

Features

- Uses PingWei advanced PerfectMOS technology
- Extremely low on-resistance $R_{DS(on)}$
- Excellent $Q_g \times R_{DS(on)}$ product(FOM)
- Excellent Low Ciss
- Qualified according to JEDEC criteria



100% DVDS Tested
100% Avalanche Tested

Applications

- PFC stages, hard switching PWM stages and resonant switching
- PWM stages for e.g. PC Silverbox, Adapter, LCD & PDP TV, Lighting, Server, Telecom and UPS

Product Summary

V_{DS}	800V
$R_{DS(on)@10V \text{ typ}}$	3.3Ω
I_D	4A

TO-252-2L

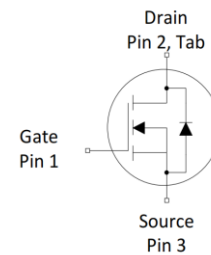
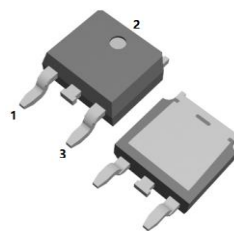

Package Marking and Ordering Information

Part #	Marking	Package	Packing	Reel Size	Tape Width	Qty
4N80G	4N80G	TO-252-2L	Tape&Reel	13 inches	16mm	2500pcs

Absolute Maximum Ratings

Parameter	Symbol	Value	Unit
Drain-source voltage	V_{DS}	800	V
Continuous drain current $T_C = 25^\circ\text{C}$ $T_C = 100^\circ\text{C}$	I_D	4 2	A
Pulsed drain current ($T_C = 25^\circ\text{C}$)	$I_{D \text{ pulse}}$	15	A
Avalanche energy, single pulse (L=10mH)	E_{AS}	152	mJ
Gate-Source voltage	V_{GS}	±30	V
Power dissipation $T_C = 25^\circ\text{C}$	P_{tot}	130	W
Operating junction and storage temperature	T_j, T_{stg}	-55...+150	°C
Soldering temperature, wave soldering only allowed at leads (1.6mm from case for 10s)	T_{sold}	260	°C

Thermal Resistance

Parameter	Symbol	Value			Unit	Test Condition
		min.	typ.	max.		
Thermal resistance, junction – case.	RthJC	-	-	1.0	°C/W	-
Thermal resistance, junction - ambient(min. footprint)	RthJA	-	-	107	°C/W	-

Electrical Characteristic (at Tj = 25 °C, unless otherwise specified)

Parameter	Symbol	Value			Unit	Test Condition
		min.	typ.	max.		

Static Characteristic

Drain-source breakdown voltage	BV _{DSS}	800	-	-	V	V _{GS} =0V, I _D =250uA
Gate threshold voltage	V _{GS(th)}	2	-	4	V	V _{DS} =V _{GS} , I _D =250uA
Zero gate voltage drain current	I _{DSS}	-	-	1	μA	V _{DS} =800V, V _{GS} =0V T _j =25°C T _j =150°C
Gate-source leakage current	I _{GSS}	-	-	±100	nA	V _{GS} =±30V, V _{DS} =0V
Drain-source on-state resistance	R _{DS(on)}	-	3.3	4.0	Ω	V _{GS} =10V, I _D =2A
Transconductance	g _{fs}	-	4	-	S	V _{DS} =10V, I _D =2A

Dynamic Characteristic

Input Capacitance	C _{iss}	-	652	-	pF	V _{GS} =0V, V _{DS} =25V, f=1MHz
Output Capacitance	C _{oss}	-	64	-		
Reverse Transfer Capacitance	C _{rss}	-	6	-		
Gate Total Charge	Q _G	-	16	-	nC	V _{DS} =400V, I _D =2A, V _{GS} =10V
Gate-Source charge	Q _{gs}	-	4	-		
Gate-Drain charge	Q _{gd}	-	6	-		
Turn-on delay time	t _{d(on)}	-	10	-	ns	V _{GS} =10V, V _{DD} =400V, R _{G_ext} =2.5Ω, I _D =2A
Rise time	t _r	-	15	-		
Turn-off delay time	t _{d(off)}	-	23	-		
Fall time	t _f	-	29	-		
Gate resistance	R _G	-	2.6	-	Ω	V _{GS} =0V, V _{DS} =0V, f=1MHz

Body Diode Characteristic

Parameter	Symbol	Value			Unit	Test Condition
		min.	typ.	max.		
Body Diode Forward Voltage	V_{SD}	-	-	1.5	V	$V_{GS}=0V, I_{SD}=2A$
Body Diode Continuous Forward Current	I_S	-	-	4	A	TC = 25°C
Body Diode Pulsed Current	I_S pulse	-	-	15	A	TC = 25°C
Body Diode Reverse Recovery Time	t_{rr}	-	-	-	ns	$I_F=2A,$ $dI/dt=100A/\mu s$
Body Diode Reverse Recovery Charge	Q_{rr}	-	-	-	nC	

Typical Performance Characteristics

Fig 1: Output Characteristics

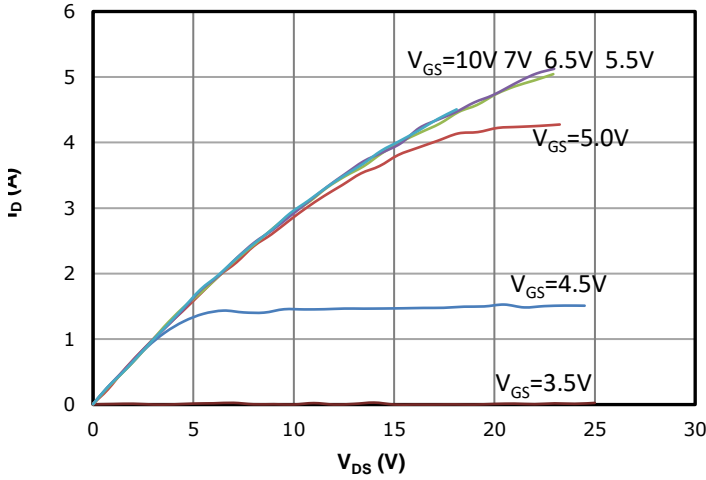

Fig 2: Transfer Characteristics

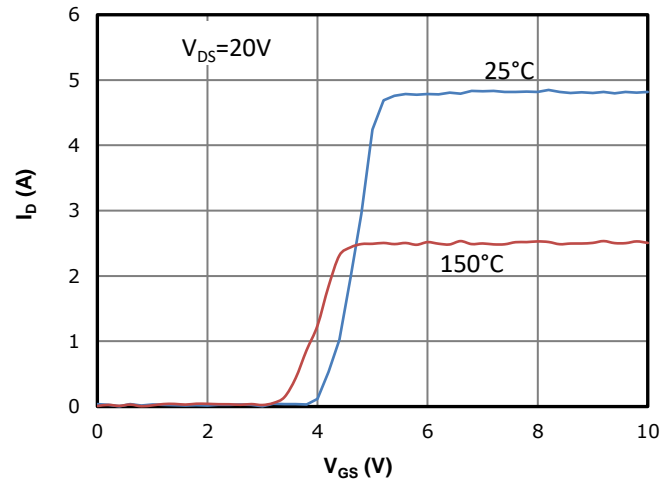

Fig 3: Rds(on) vs Drain Current and Gate Voltage

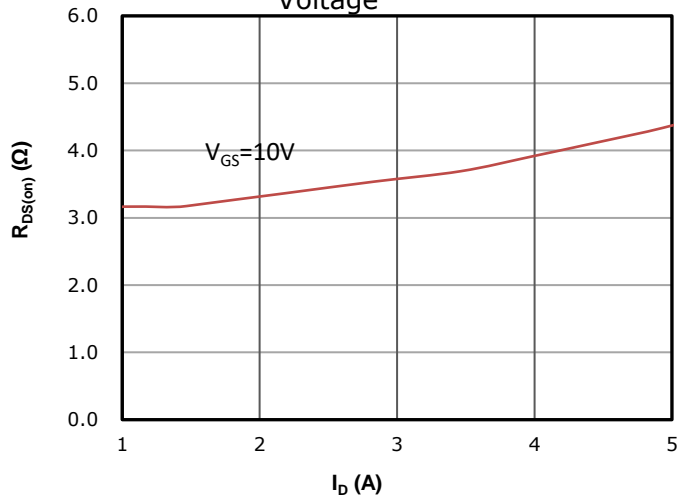

Fig 4: Rds(on) vs Gate Voltage

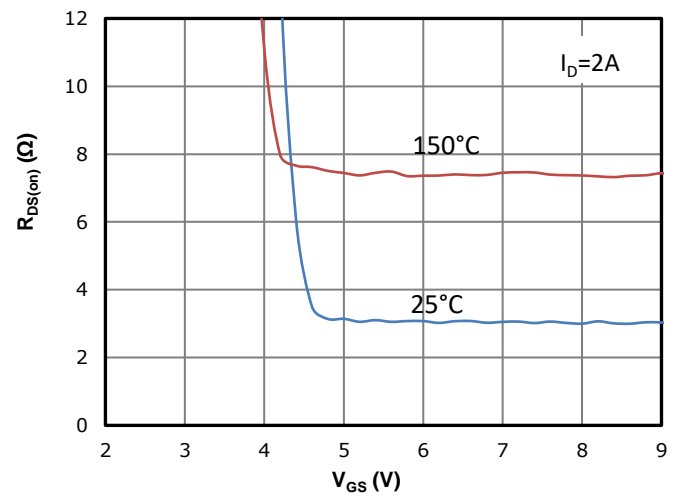

Fig 5: Rds(on) vs. Temperature

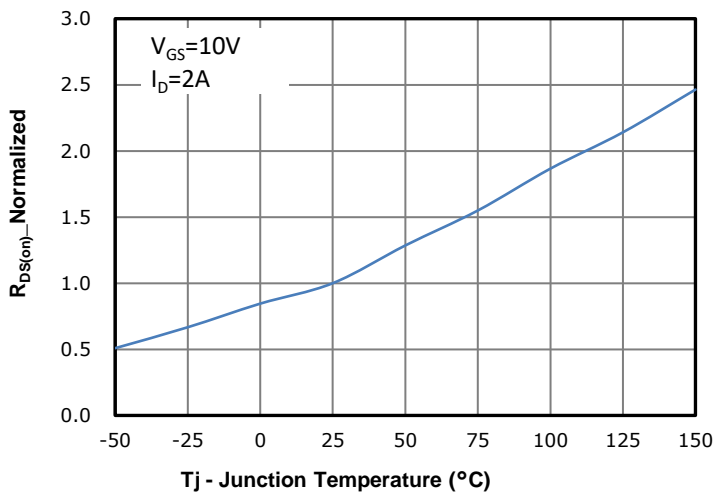

Fig 6: Vgs(th) vs. Temperature

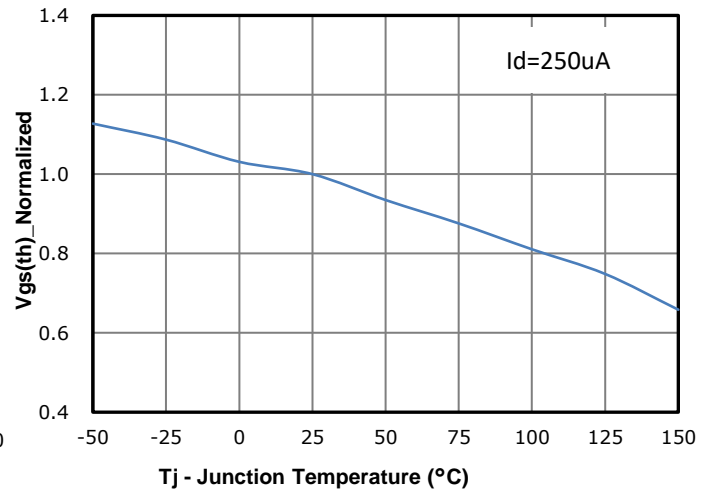

Fig 7: BVdss vs. Temperature

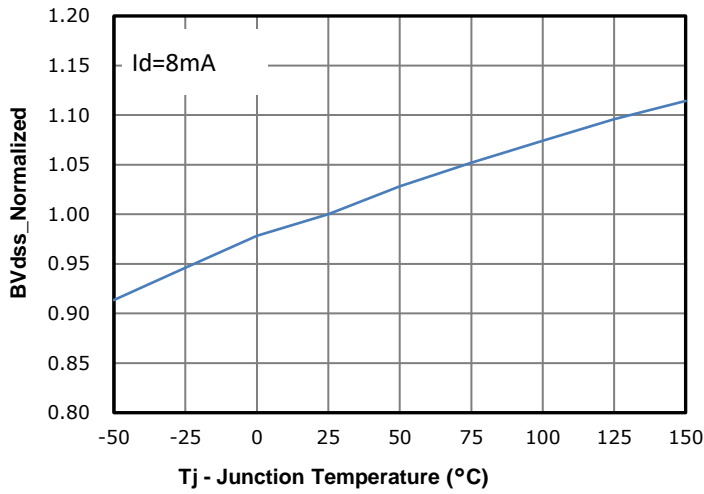

Fig 8: Capacitance Characteristics

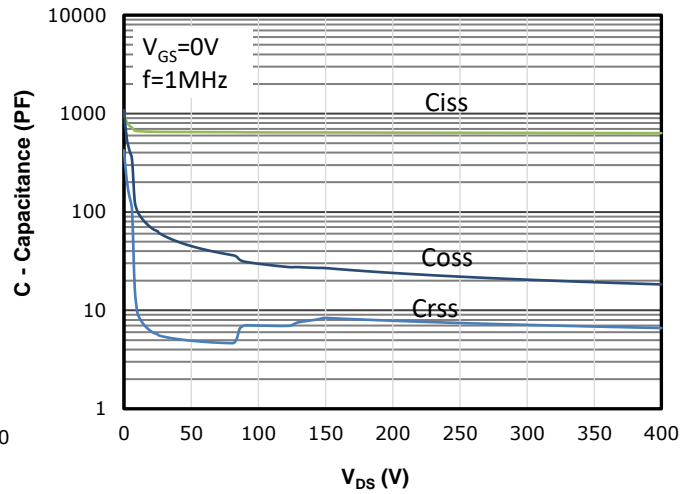

Fig 9: Gate Charge Characteristics

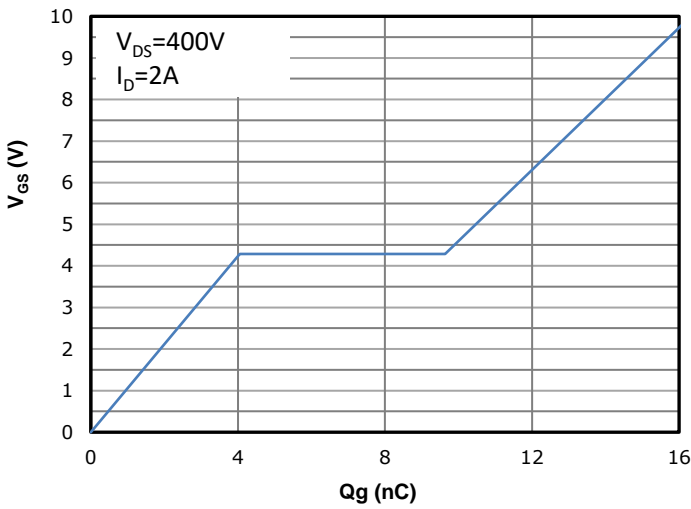

Fig 10: Body-diode Forward Characteristics

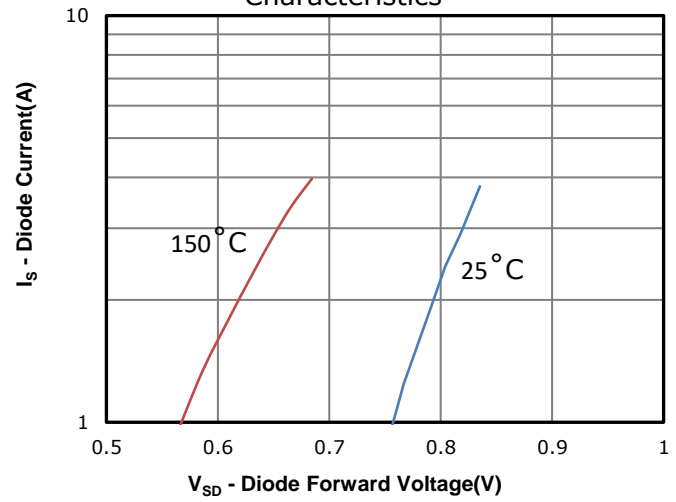

Fig 11: Power Dissipation

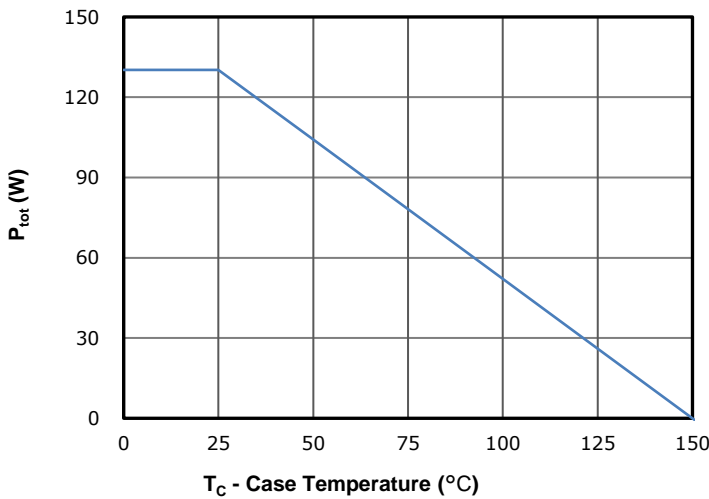

Fig 12: Drain Current Derating

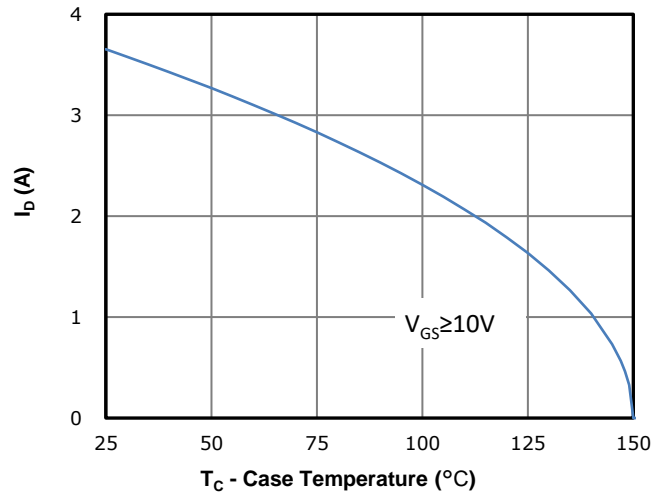

Fig 13: Safe Operating Area

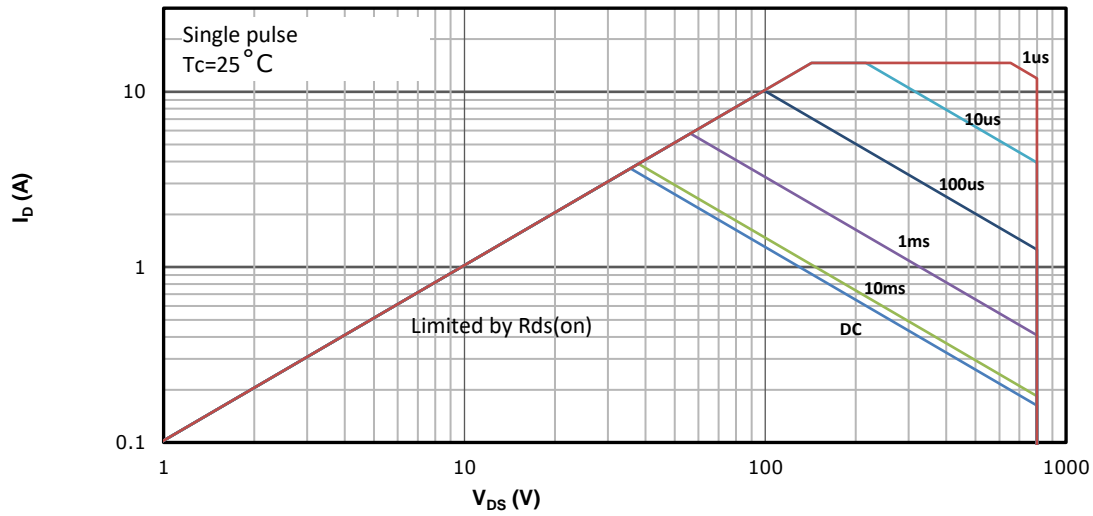
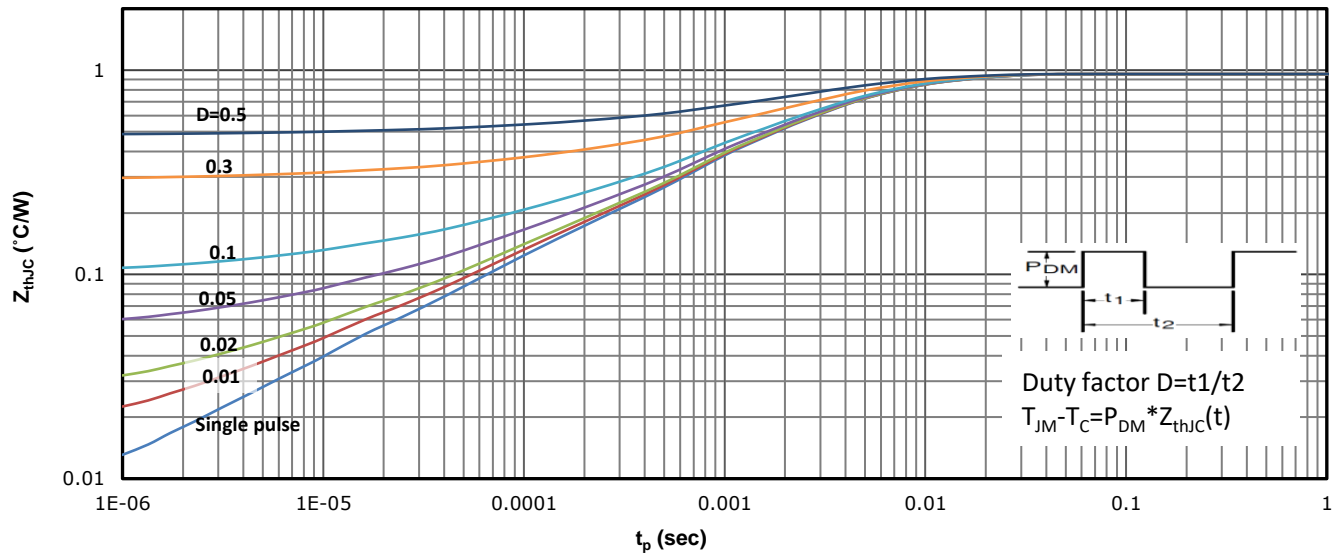
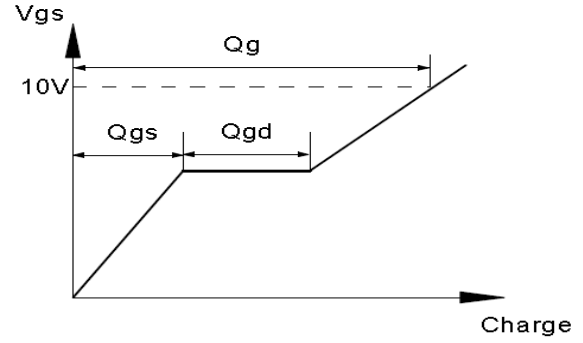
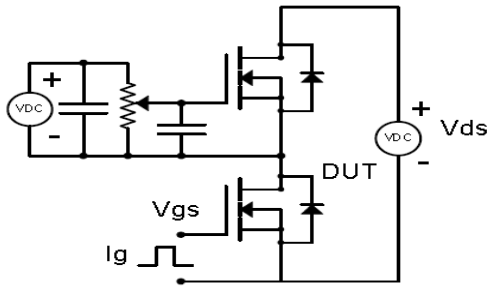

Fig 14: Max. Transient Thermal Impedance



Test Circuit & Waveform

Gate Charge Test Circuit & Waveform



Resistive Switching Test Circuit & Waveforms

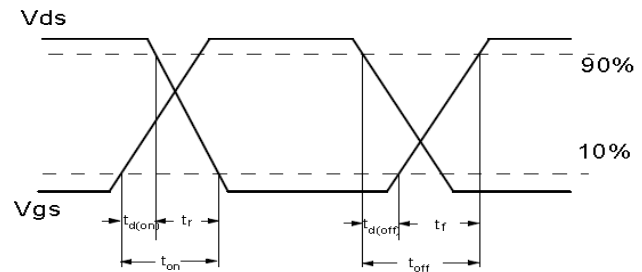
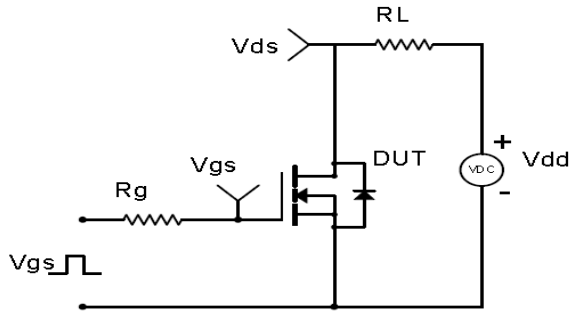

Unclamped Inductive Switching (UIS) Test Circuit & Waveforms

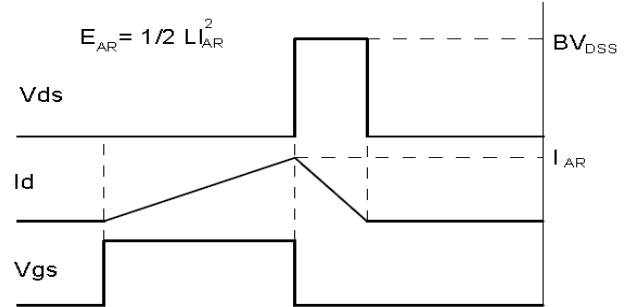
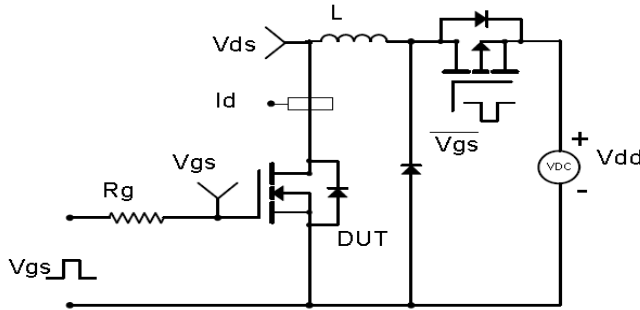

Diode Recovery Test Circuit & Waveforms

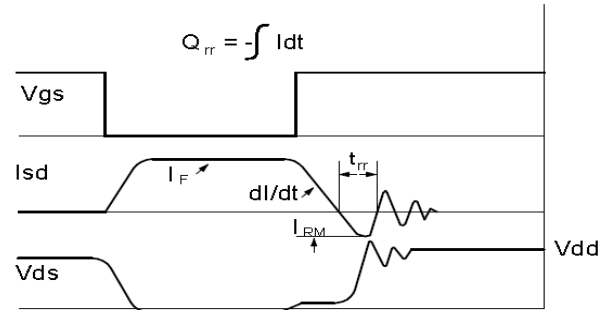
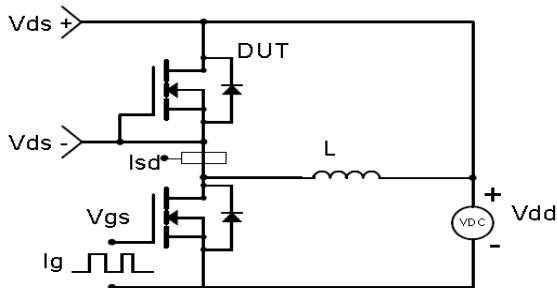

Package Outline: TO-252-2L

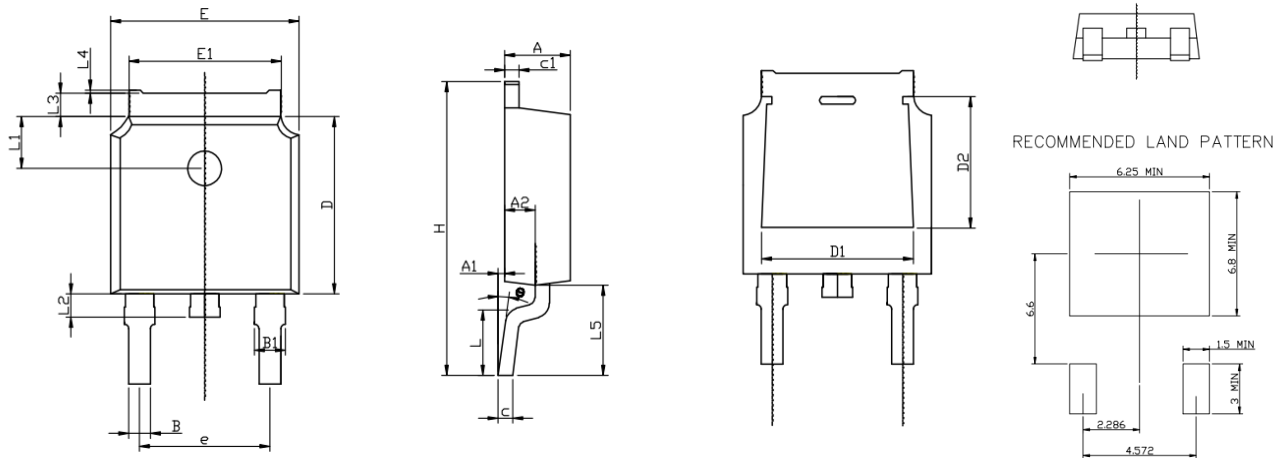

UNIT: mm

SYMBOL	MILLIMETERS		INCHES	
	MIN	MAX	MIN	MAX
A	2.15	2.45	0.085	0.096
A1	0.05	0.20	0.002	0.008
A2	0.91	1.22	0.036	0.048
B	0.66	0.86	0.026	0.034
B1	0.93	1.23	0.037	0.048
C	0.40	0.60	0.016	0.024
C1	0.40	0.60	0.016	0.024
D	5.95	6.25	0.234	0.246
D1	4.80		0.189	
D2	3.80		0.150	
E	6.45	6.75	0.254	0.266
E1	5.12	5.52	0.202	0.217
L	1.65		0.065	
L1	1.58	1.98	0.062	0.078
L2	0.60	1.00	0.024	0.039
L3	0.70	1.00	0.028	0.039
L4	0.00	0.20	0.000	0.008
L5	2.80	3.40	0.110	0.134
H	9.80	10.40	0.386	0.409
θ	0.00	8.00	0.000	0.315
e	4.57		0.180	

Disclaimer

Any and all semiconductor products have certain probability to fail or malfunction, which may result in personal injury, death or property damage. Customer are solely responsible for providing adequate safe measures when design their systems.

Unless otherwise specified in the datasheet, the product is designed and qualified as a standard commercial product and is not intended for use in applications that require extraordinary levels of quality and reliability, such as automotive, aviation/aerospace and life-support devices or systems.

Buyer is responsible for its products and applications using PingWei products, including compliance with all laws, regulations and safety requirements or standards, regardless of any support or applications information provided by PingWei.

"Typical" parameters which may be provided in PingWei data sheets and/or specifications can and do vary in different applications and actual performance may vary over time. All operating parameters, including "Typicals" must be validated for each customer application by customer's technical experts

ALL PRODUCT, PRODUCT SPECIFICATIONS AND DATA ARE SUBJECT TO CHANGE WITHOUT NOTICE TO IMPROVE RELIABILITY, FUNCTION OR DESIGN OR OTHERWISE