

## HBR30150BCT&HBR30150HCT

### 30.0AMPS. SCHOTTKY BARRIER RECTIFIERS

#### FEATURE

- . High current capability
- . Ultra low forward voltage drop
- . Low power loss, high efficiency
- . High surge capability
- . High temperature soldering guaranteed  
260°C /10seconds, 0.25"(6.35mm)from case.

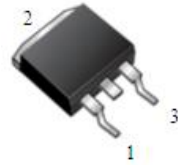

TO-263-2L  
HBR30150BCT



TO-262-3L  
HBR30150HCT

#### MECHANICAL DATA

- . Case: Molded with UL-94 Class V-0 recognized  
Flame Retardant Epoxy
- . Mounting position: any

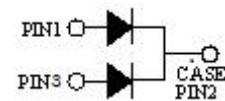

Single phase, half wave, 60Hz, resistive or inductive load.

For capacitive load, derate current by 20%

#### MAXIMUM RATINGS (T<sub>C</sub>=25°C unless otherwise noted)

Parameter	Symbol	HBR30150BCT&HBR30150HCT	Units
Maximum Recurrent Peak Reverse Voltage	$V_{RRM}$	150	V
Maximum RMS Voltage	$V_{RMS}$	105	V
Maximum DC blocking Voltage	$V_{DC}$	150	V
Maximum Average Forward Rectified Current <i>Per Leg</i> at T <sub>C</sub> =100°C <i>Total device</i>	$I_{F(AV)}$	15.0 30.0	A
Peak Forward Surge Current 8.3ms single half sine-wave superimposed on rated load (JEDEC method) <i>Per Leg</i>	$I_{FSM}$	200.0	A
Typical Junction Capacitance (Note 1)	$C_J$	230	pF
Operation Junction Temperature and Storage Temperature	$T_J, T_{STG}$	-55 to +175	°C

#### ELECTRICAL CHARACTERISTICS-(per leg) (T<sub>A</sub>=25°C unless otherwise noted)

Parameter	Symbol	Test conditions	Typ	Max	Units	
Forward voltage drop	$V_F$	$T_J=25\text{ }^\circ\text{C}$	IF= 10.0A	0.79	---	V
			IF=15.0A	0.83	0.88	
		$T_J=125\text{ }^\circ\text{C}$	IF= 10.0A	0.64	---	
			IF=15.0A	0.70	0.75	
Reverse leakage Current	$I_R$	$T_J=25\text{ }^\circ\text{C}$	VR=150V	----	50	μA
		$T_J=125\text{ }^\circ\text{C}$	VR=150V	----	10	mA

#### THERMAL CHARACTERISTICS(T<sub>C</sub>=25°C unless otherwise noted)

Parameter	Symbol	HBR30150BCT	HBR30150HCT	Units
Typical Thermal Resistance (Note 2)	$R_{(JC)}$	2.0	2.0	°C/W

#### Notes:

1. Measured at 1.0 MHz and applied reverse voltage of 4.0Vdc
2. Thermal Resistance from Junction to Case

RATING AND CHARACTERISTIC CURVES

FIG.1-TYPICAL FORWARD CURRENT DERATING CURVE

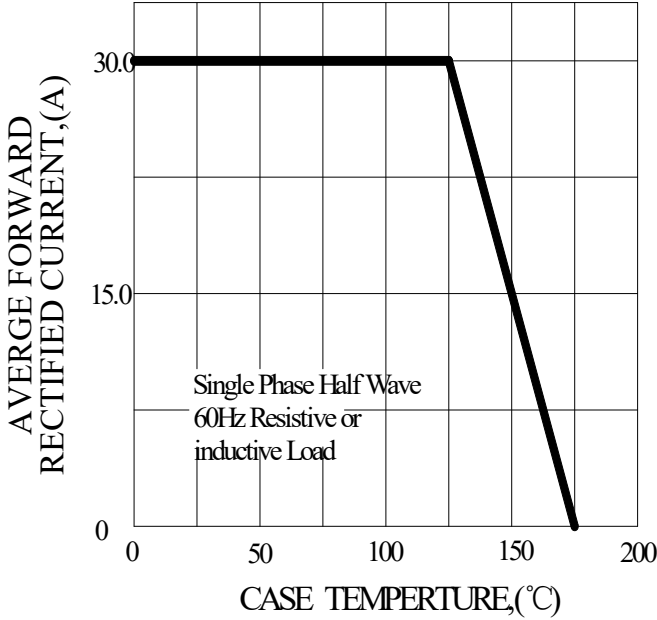

FIG.2-TYPICAL INSTANTANEOUS FORWARD CHARACTERISTICS

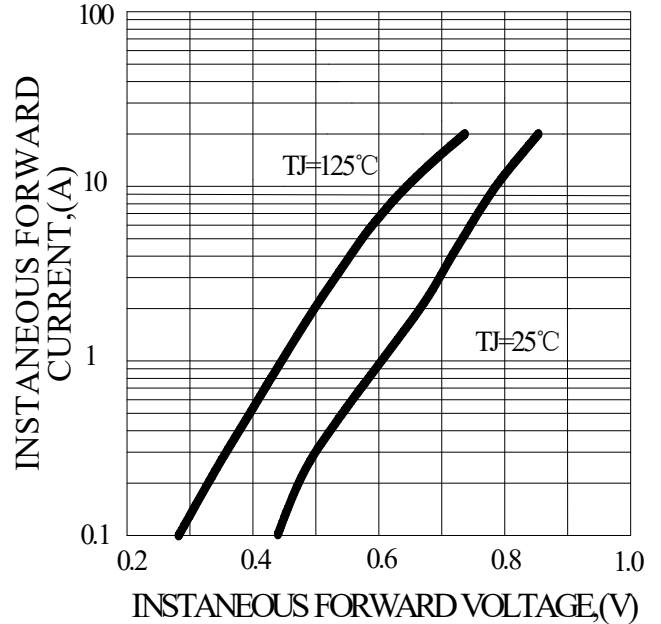

FIG.3-MAXIMUM NON-REPETITIVE FORWARD SURGE CURRENT

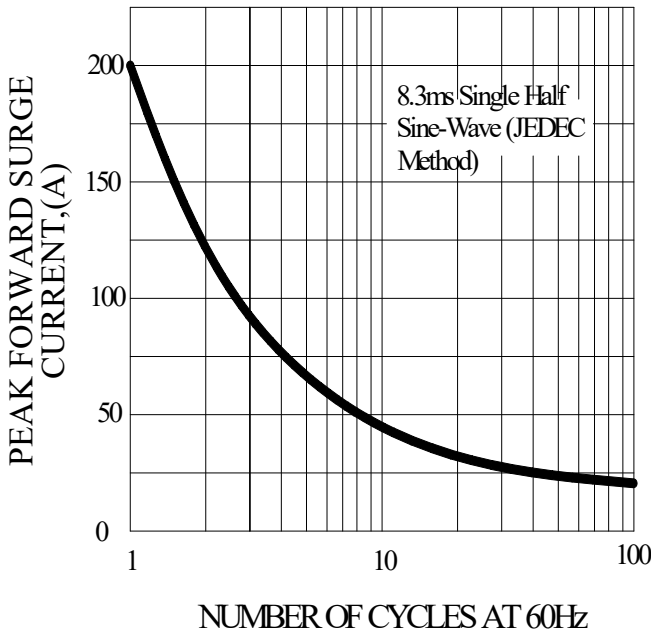
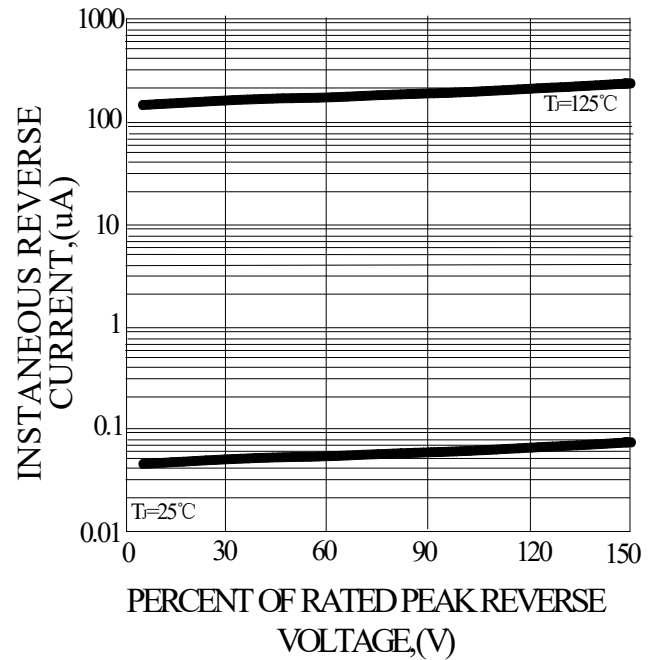
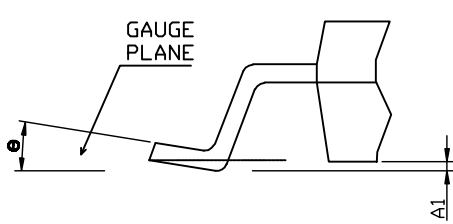
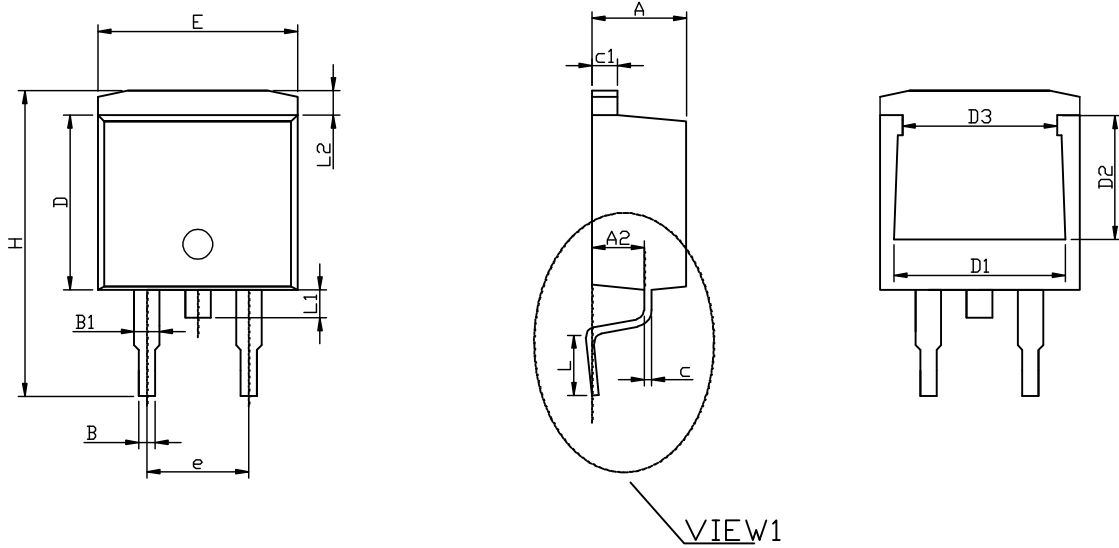

FIG.4-TYPICAL REVERSE CHARACTERISTICS



# TO-263-2L PACKAGE OUTLINE



VIEW1

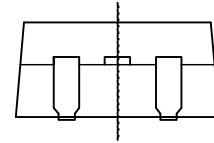

## RECOMMENDED LAND PATTERN

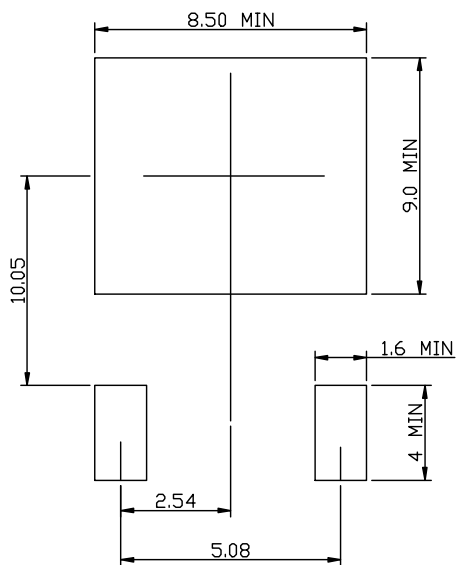

	MIN	NOM	MAX
A	4.50	4.70	4.90
A1	0.05	0.15	0.30
A2	2.45	2.60	2.70
B	0.72	0.82	0.92
B1	1.12	1.27	1.42
c	0.28	0.38	0.48
c1	1.17	1.27	1.37
D	8.46	8.66	8.86
D1	7.90	8.10	8.40
D2	5.50	5.70	5.90
D3	7.10	7.30	7.50
E	9.85	10.15	10.45
e		5.08BCS	
H	14.75	15.15	15.55
L	2.30	2.55	2.80
L1	1.20	1.40	1.60
L2	1.01	1.23	1.50
θ	0°	7°	8°

UNIT: mm

## TO-262-3L PACKAGE OUTLINE



RECOMMENDED LAND PATTERN

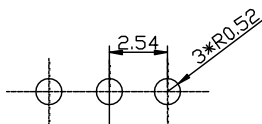

UNIT: mm

	MIN	NOM	MAX
A	4.50	4.70	4.90
A1	2.45	2.60	2.70
B	0.72	0.82	0.92
B1	1.12	1.27	1.42
c	0.28	0.38	0.48
c1	1.17	1.27	1.37
D	8.46	8.66	8.86
D1	7.90	8.10	8.40
D2	5.50	5.70	5.90
D3	7.10	7.30	7.50
E	9.85	10.15	10.45
e		2.54	
H	23.20	23.60	24.00
L	13.10	13.60	14.10
L1	3.85	4.05	4.35
L2	1.01	1.23	1.50