

## GBU1006 THRU GBU1010

### SINGLE PHASE 10.0AMPS. GLASS PASSIVATED BRIDGE RECTIFIERS

#### FEATURE

- . UL Listed Under Recognized Component Index, File Number E338195
- . Glass passivated chip junctions
- . High case dielectric strength
- . Low Reverse Leakage Current
- . High surge current capability
- . Ideal for Printed Circuit Board Applications

#### MECHANICAL DATA

- . Case Material: Molded Plastic.
- . UL Flammability Classification Rating 94V-0
- . Terminals: Pure tin plated, Lead free.
- . Leads solderable per MIL-STD-750, Method 2026.
- . Polarity: Molded on Body
- . Mounting: Through Hole for #6 Screw
- . Mounting Torque: 5.0 in-lbs Maximum

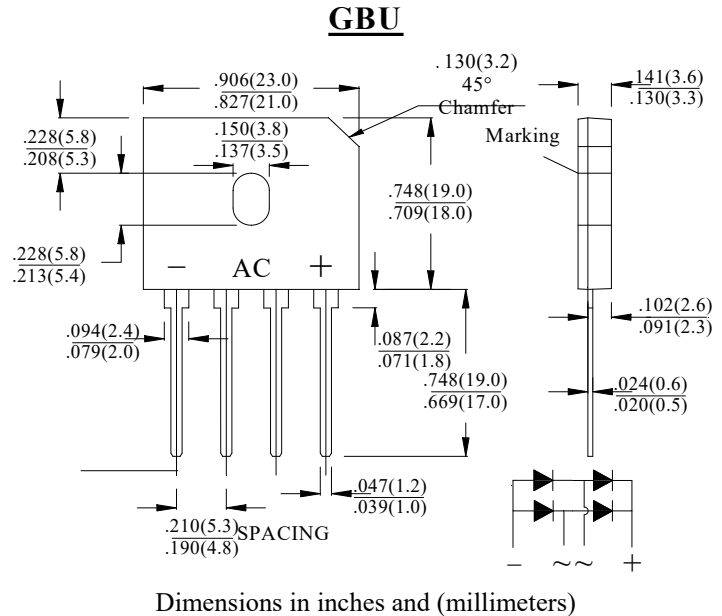

### MAXIMUM RATINGS AND ELECTRICAL CHARACTERISTICS

Ratings at 25°C ambient temperature unless otherwise specified.

Single phase, half wave, 60Hz, resistive or inductive load. For capacitive load, derate current by 20%

Type Number	SYM BOL	GBU1006	GBU1008	GBU1010	units
Maximum Recurrent Peak Reverse Voltage	$V_{RRM}$	600	800	1000	V
Maximum RMS Voltage	$V_{RMS}$	420	560	700	V
Maximum DC blocking Voltage	$V_{DC}$	600	800	1000	V
Maximum Average Forward (with heatsink Note2) Rectified Current @ $T_C=100^\circ\text{C}$ (without heatsink)	$I_{F(AV)}$		10.0 3.0		A
Peak Forward Surge Current 8.3ms single half sine-wave superimposed on rate load (JEDEC method)	$I_{FSM}$		220		A
Maximum Forward Voltage @ 10.0A DC Drop per element @ 5.0A DC	$V_F$		1.1 1.0		V
Maximum DC Reverse Current @ $T_J=25^\circ\text{C}$ at rated DC blocking voltage @ $T_J=125^\circ\text{C}$	$I_R$		5.0 500.0		$\mu\text{A}$
$I^2t$ Rating for Fusing ( $t < 8.3\text{ms}$ )	$I^2t$		200		$\text{A}^2\text{Sec}$
Typical Junction Capacitance (Note 1)	$C_J$		70		pF
Typical Thermal Resistance (Note 2)	$R_{(JC)}$		2.0		$^\circ\text{C}/\text{W}$
Storage Temperature	$T_{STG}$		-55 to +150		$^\circ\text{C}$
Operating Junction Temperature	$T_J$		-55 to +150		$^\circ\text{C}$

**Note:** 1. Measured at 1.0 MHz and applied reverse voltage of 4.0Vdc

2. Device mounted on 150mm x 150mm x 1.6mm Cu Plate Heatsink.

**RATING AND CHARACTERISTIC CURVES**

FIG.1-TYPICAL FORWARD CURRENT DERATING CURVE

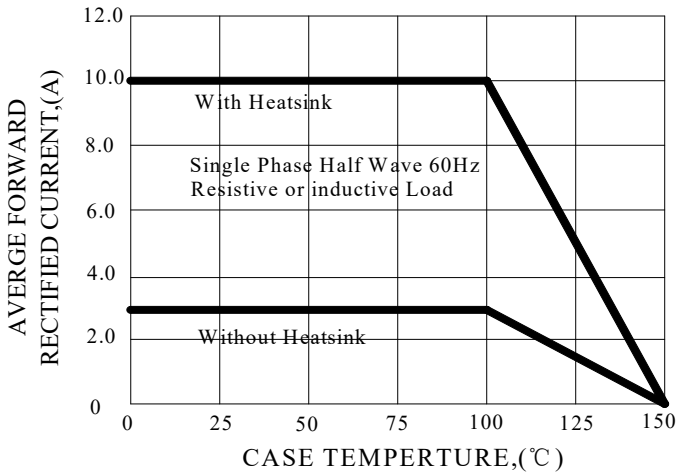

FIG.2-TYPICAL INSTANTANEOUS FORWARD CHARACTERISTICS

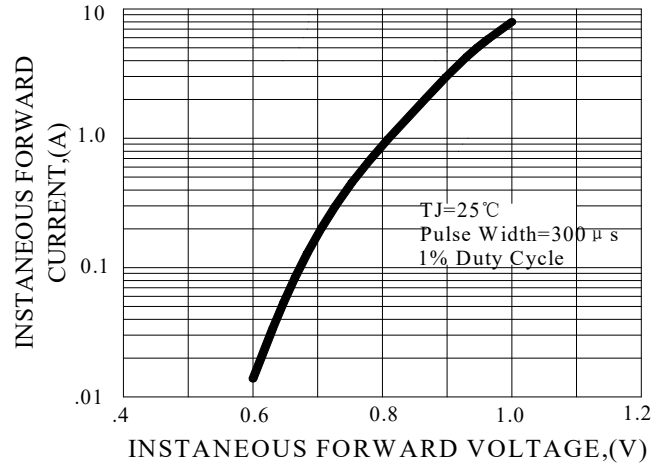

FIG.3-MAXIMUM NON-REPETITIVE FORWARD SURGE CURRENT

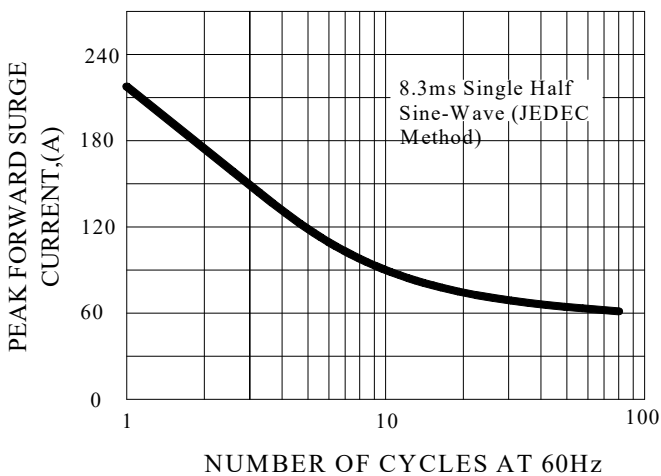

FIG.4-TYPICAL JUNCTION CAPACITANCE

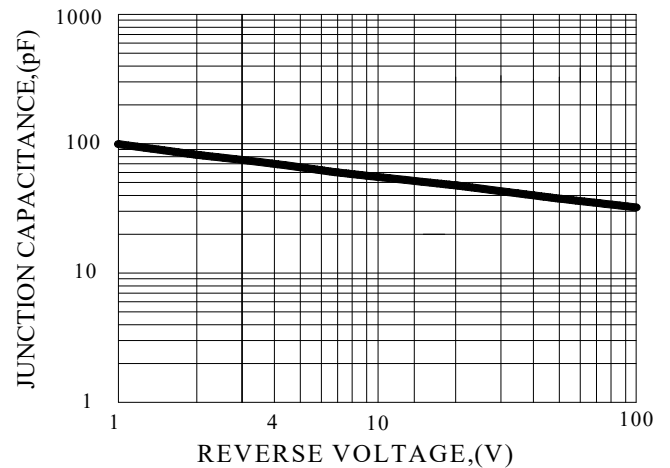
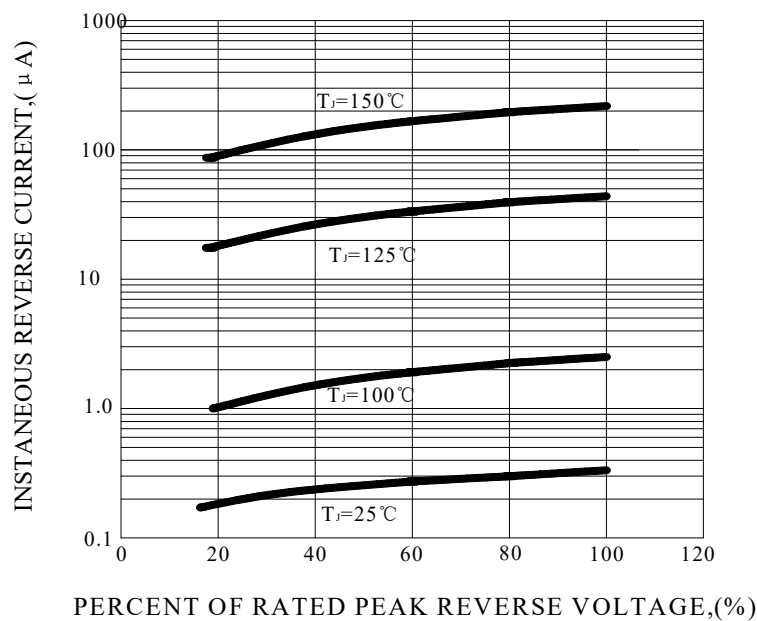
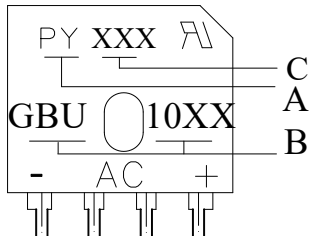

FIG.5-TYPICAL REVERSE CHARACTERISTICS



## Marking and packaging illustration

### 1、Marking



SYMBOL	Explanation
<b>A</b>	Trademark
<b>B</b>	Product Name
<b>C</b>	Date code

### 2、Packaging

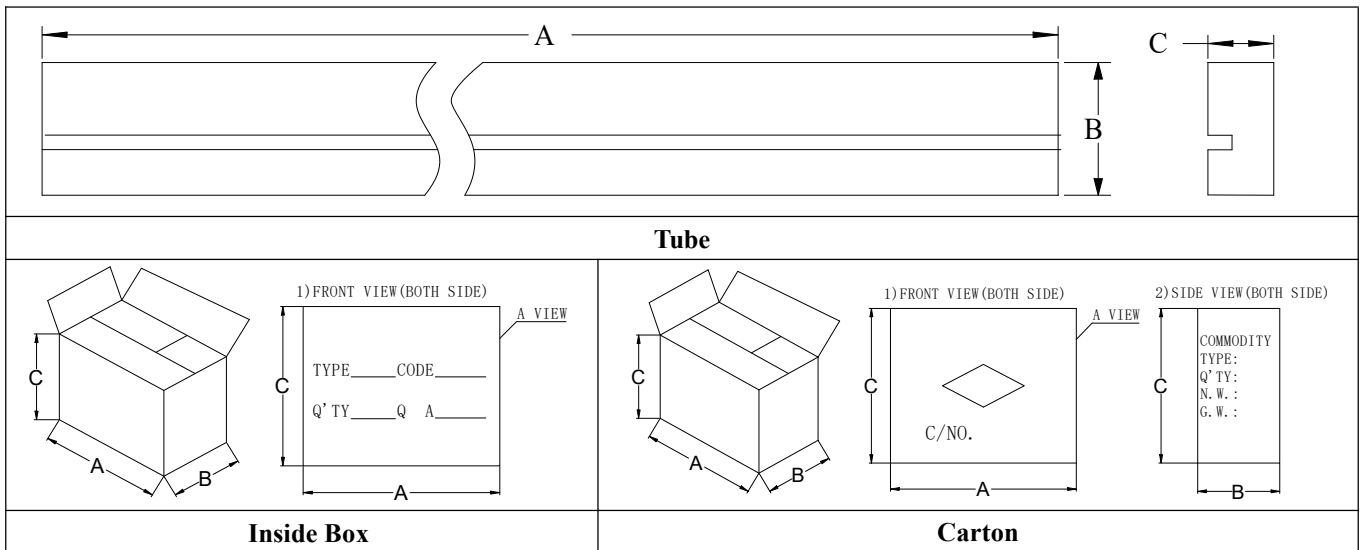

OUTLINE	A (mm)	B (mm)	C (mm)
Tube	470±1	41±1	7.0±1
Inner box	485±3	130±3	130±3
Carton	500±5	285±5	150±5
COUNT	TUBE (PCS)	BOX (PCS)	CARTON (PCS)
GBU	20	1000	2000