

## MUR3JGR

### 3.0AMPS .GLASS PASSIVATED ULTRA FAST RECTIFIERS

#### FEATURE

- . Glass passivated chip
- . High current capability
- . Low forward voltage drop
- . High surge capability
- . Superfast recovery time for high efficiency
- . High temperature soldering guaranteed  
260°C /1 0sec/0.375" lead length at 5 lbs tension

#### MECHANICAL DATA

- . Case: Molded plastic
- . Epoxy: UL94V-0 rate flame retardant
- . Lead: MIL-STD- 202E, Method 208 guaranteed
- . Polarity:Color band denotes cathode end
- . Mounting position: Any

#### SMC (DO-214AB)

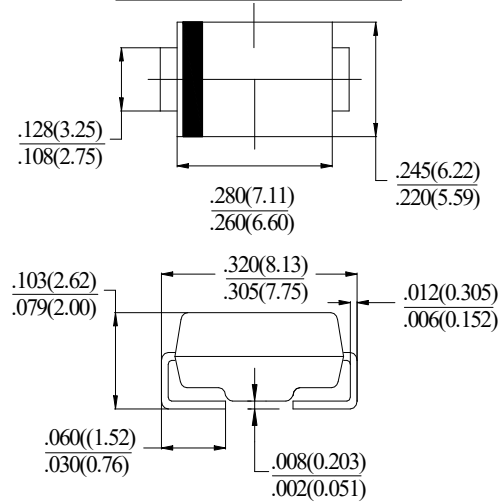

Dimensions in inches and (millimeters)

#### MAXIMUM RATINGS AND ELECTRICAL CHARACTERISTICS

Ratings at 25°C ambient temperature unless otherwise specified.

Single phase, half wave, 60Hz, resistive or inductive load. For capacitive load, derate current by 20%

Type Number	SYM BOL	MUR3JGR	units
Maximum Recurrent Peak Reverse Voltage	$V_{RRM}$	600	V
Maximum RMS Voltage	$V_{RMS}$	420	V
Maximum DC blocking Voltage	$V_{DC}$	600	V
Maximum Average Forward Rectified Current	$I_{F(AV)}$	3.0	A
Peak Forward Surge Current 8.3ms single half sine- wave superimposed on rated load (JEDEC method)	$I_{FSM}$	90.0	A
Maximum Forward Voltage at 3.0A DC	$V_F$	1.30	V
Maximum DC Reverse Current @ $T_j=25^\circ\text{C}$ at rated DC blocking voltage @ $T_j=125^\circ\text{C}$	$I_R$	5.0 100.0	$\mu\text{A}$
Maximum Reverse Recovery Time (Note 1)	$t_{rr}$	50	nS
Typical Junction Capacitance (Note 2)	$C_J$	35	pF
Typical Thermal Resistance (Note 3)	$R_{(JL)}$	8	$^\circ\text{C}/\text{W}$
	$R_{(JC)}$	10	
Storage Temperature	$T_{STG}$	-55 to +150	$^\circ\text{C}$
Operation Junction Temperature	$T_J$	-55 to +150	$^\circ\text{C}$

#### Note:

1. Test Conditions:  $I_F=0.5\text{A}$ ,  $I_R=1.0\text{A}$ ,  $I_{RR}=0.25\text{A}$
2. Measured at 1.0 MHz and applied reverse voltage of 4.0Vdc
3. Measured on P.C.Board with 15.0×15.0mm Copper Pad Areas.

**RATING AND CHARACTERISTIC CURVES**

FIG.1-TYPICAL FORWARD CURRENT DERATING CURVE

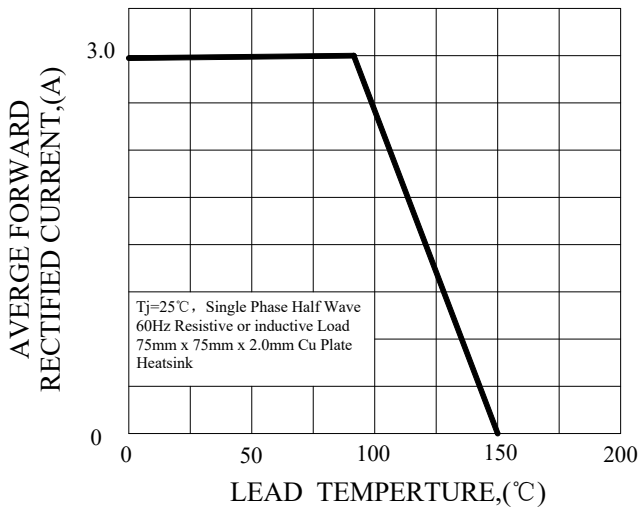

FIG.2-TYPICAL INSTANTANEOUS FORWARD CHARACTERISTICS

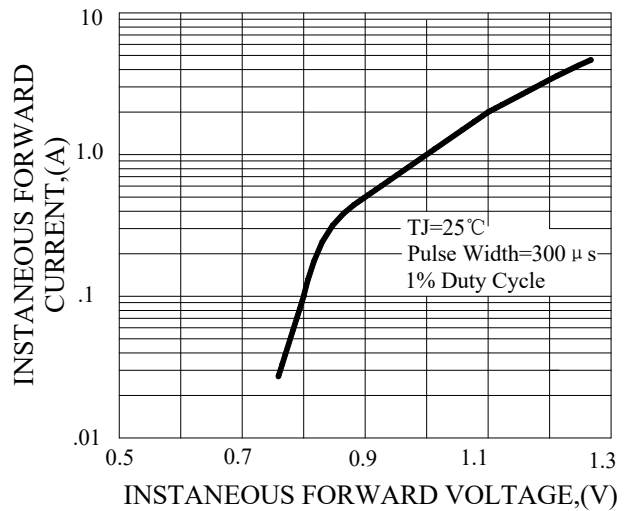

FIG.3-MAXIMUM NON-REPETITIVE FORWARD SURGE CURRENT

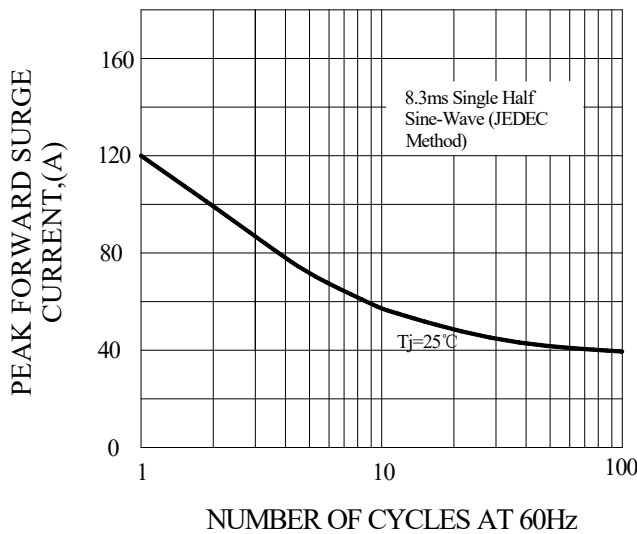

FIG.4-TYPICAL REVERSE CHARACTERISTICS

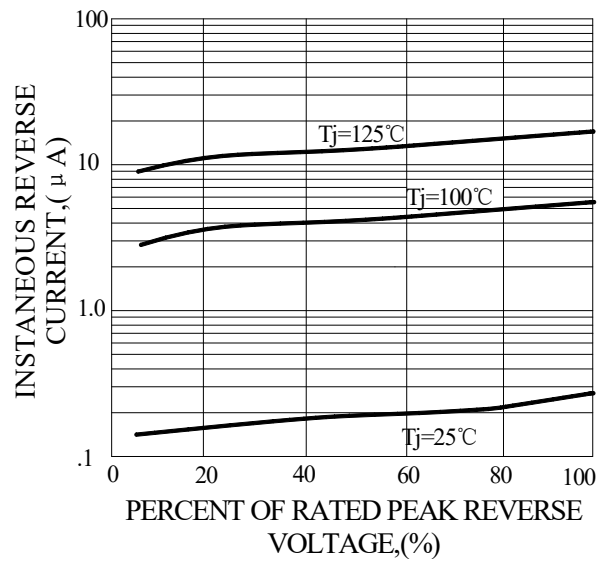

FIG.5-TYPICAL JUNCTION CAPACITANCE

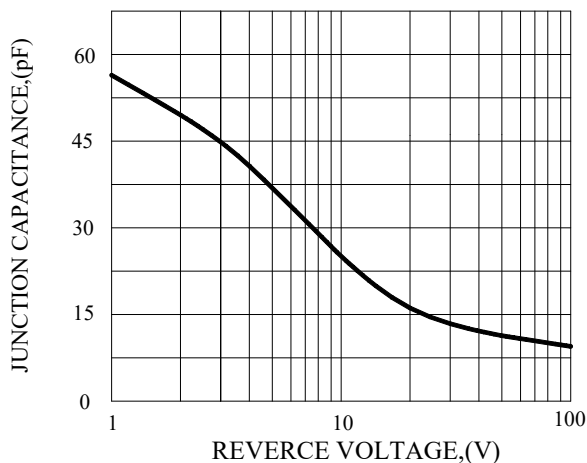
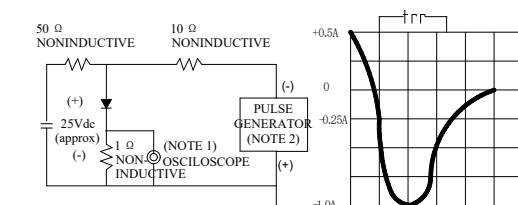

FIG.6-TEST CIRCUIT DIAGRAM AND REVERSE RECOVERY TIME CHARACTERISTIC



NOTES:1. Rise Time=7ns max, Input Impedance= 1 megohm,22pF.  
2. Rise Time=10ns max, Source Impedance= 50 ohms.

## Marking and packaging illustration

### 1、Marking

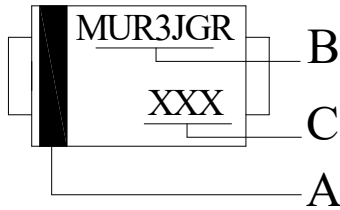

SYMBOL	Explanation
A	Color Band Denotes Cathode
B	Product Name
C	Date code

### 2、Packaging

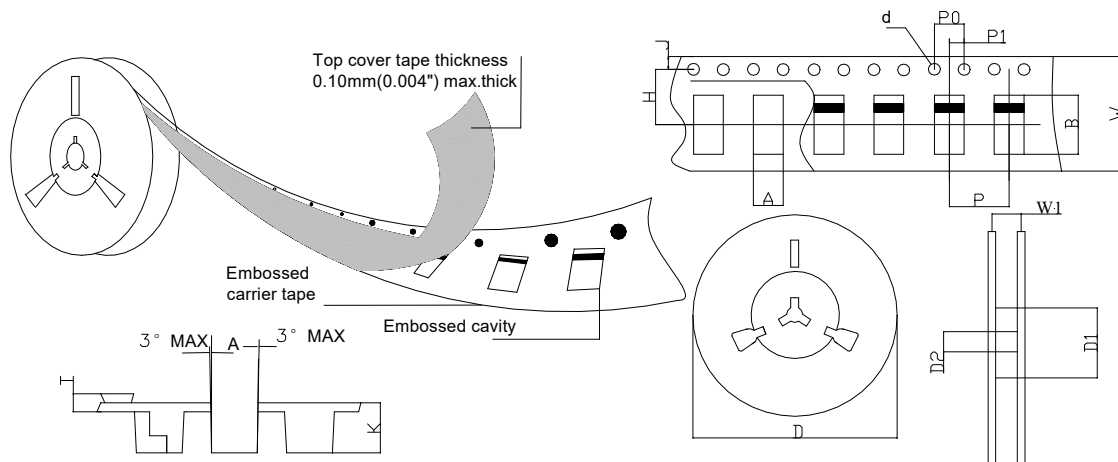

SPECIFICATIONS mm(inch)		PACKAGE	SPECIFICATIONS mm(inch)		PACKAGE
ITEM	SYM BOL	SMC (DO-214AB)	ITEM	SYM BOL	SMC (DO-214AB)
Carrier width	A	6.15(0.242)Max	Carrier depth	K	2.54(0.100)Typ
Carrier length	B	8.41(0.331)Max	Punch hole pitch	P	8.00(0.315)Typ
Sprocket hole	d	ø1.55(0.061)Typ	Sprocket hole pitch	P0	4.00(0.157)Typ
Reel outer diameter	D	330.0(13.0)Typ	Embossment center	P1	2.00(0.079)Typ
Reel inner diameter	D1	74.0(2.913)Min	Overall tape thickness	T	0.25(0.010)Typ
Feed hole diameter	D2	13.0(0.512)Typ	Tape width	W	16.0(0.430)Typ
Sprocket hole position	J	1.75(0.069)Typ	Reel width	W1	16.5(0.650)Min
Punch hole position	H	7.50(0.295)Typ			