

Schottky Barrier Rectifier Diode

30A,100V

FEATURE

- ◆ High current capability
- ◆ Ultra low forward voltage drop
- ◆ Low power loss, high efficiency
- ◆ High surge capability
- ◆ High temperature soldering guaranteed
260°C /10seconds, 0.25"(6.35mm)from case

MECHANICAL DATA

- ◆ Case: Molded with UL-94 Class V-0 recognized
Flame Retardant Epoxy
- ◆ Mounting position: any

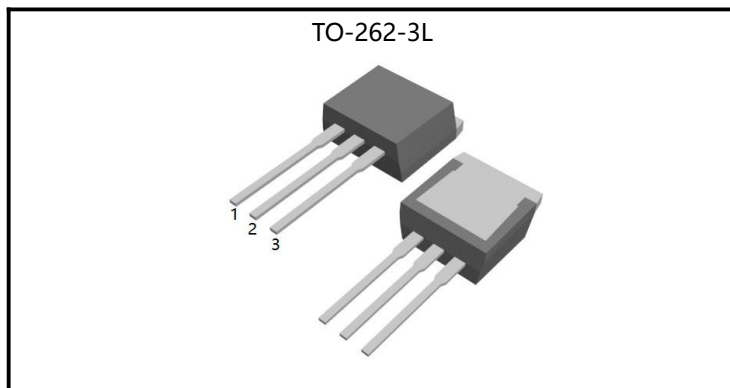

Parameter	Values	Unit
$I_{F(AV)}$	30	A
V_{RRM}	100	V
T_J	150	°C
$V_F(max)$	0.85	V
I_{FSM}	175	A

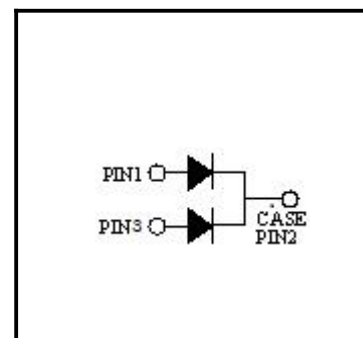

Ordering Code	Marking	Package	Packaging
PS30U100HCT	PS30U100HCT	TO-262-3L	Tube



Absolute Maximum Ratings($T_C=25^{\circ}\text{C}$, unless otherwise noted)

Parameter	Symbol	Values			Unit	Note/Test Conditions
		Min	Typ	Max		
Maximum Repetitive Peak Reverse Voltage	V_{RRM}	-	-	100	V	-
Maximum RMS Voltage	V_{RMS}	-	-	70	V	-
Maximum DC blocking Voltage	V_{DC}	-	-	100	V	-
Maximum Average Forward Rectified Current	$I_{F(AV)}$	-	-	15 30	A	Per Leg Total device, $T_C=100^{\circ}\text{C}$
Non-Repetitive Forward Surge Current	Per Leg I_{FSM}	-	-	175	A	$T_C=25^{\circ}\text{C}$, $t_p=8.3\text{ms}$, Half Sine Wave
Typical Junction Capacitance	C_J	-	1874	-	pF	Measured at 1.0 MHz and applied reverse voltage of 4.0Vdc
Operating Junction and Storage Temperature Range	T_J, T_{STG}	-55	-	150	$^{\circ}\text{C}$	-

Thermal Characteristics

Parameter	Symbol	Values			Unit	Note/Test Conditions
		Min	Typ	Max		
Thermal resistance , Channel to Case	$R_{th(ch-c)}$	-	-	2.5	$^{\circ}\text{C}/\text{W}$	-

Electrical Characteristics-(per leg)($T_C=25^{\circ}\text{C}$, unless otherwise noted)

Parameter	Symbol	Values			Unit	Note/Test Conditions
		Min	Typ	Max		
Reverse Breakdown Voltage	V_{RRM}	100	-	-	V	$I_R=100\mu\text{A}$
Forward Voltage Drop	V_F	-	0.44	-	V	$I_F=2\text{A}, T_J=25^{\circ}\text{C}$
		-	0.34	-		$I_F=2\text{A}, T_J=125^{\circ}\text{C}$
Forward Voltage Drop	V_F	-	0.52	-	V	$I_F=5\text{A}, T_J=25^{\circ}\text{C}$
		-	0.47	-		$I_F=5\text{A}, T_J=125^{\circ}\text{C}$
Forward Voltage Drop	V_F	-	0.74	0.85	V	$I_F=15\text{A}, T_J=25^{\circ}\text{C}$
		-	0.66	0.75		$I_F=15\text{A}, T_J=125^{\circ}\text{C}$
Reverse Leakage Current	I_R	-	4.8	100	μA	$V_R=100\text{V}, T_J=25^{\circ}\text{C}$
		-	4067	15000		$V_R=100\text{V}, T_J=125^{\circ}\text{C}$



RATING AND CHARACTERISTIC CURVES

FIG.1-TYPICAL FORWARD CURRENT DERATING CURVE

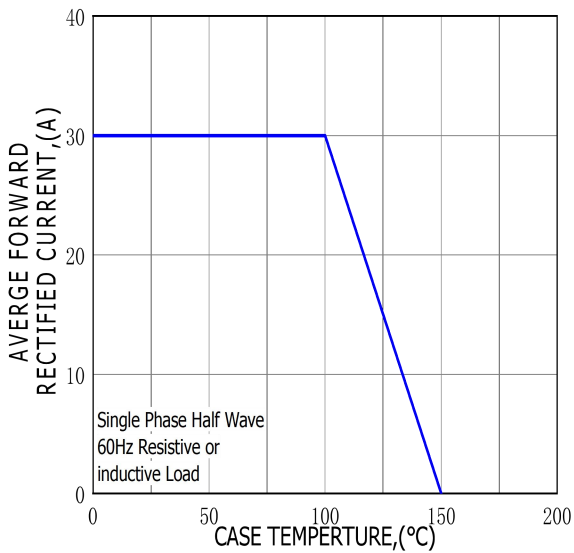

FIG.2-TYPICAL INSTANTANEOUS FORWARD CHARACTERISTICS

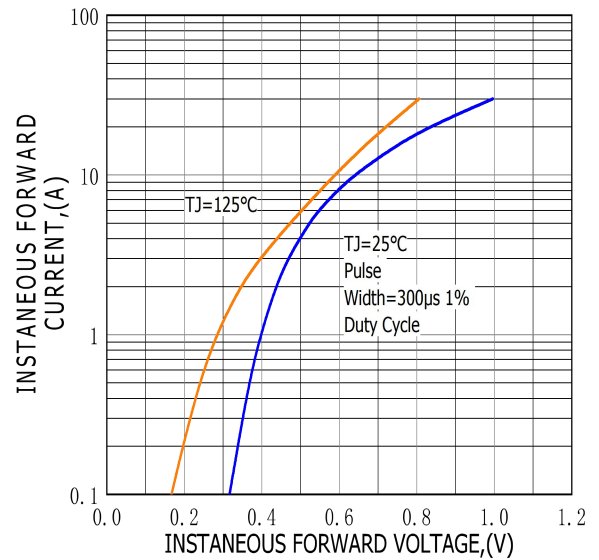

FIG.3-MAXIMUN NON-REPETITIVE FORWARD SURGE CURRENT

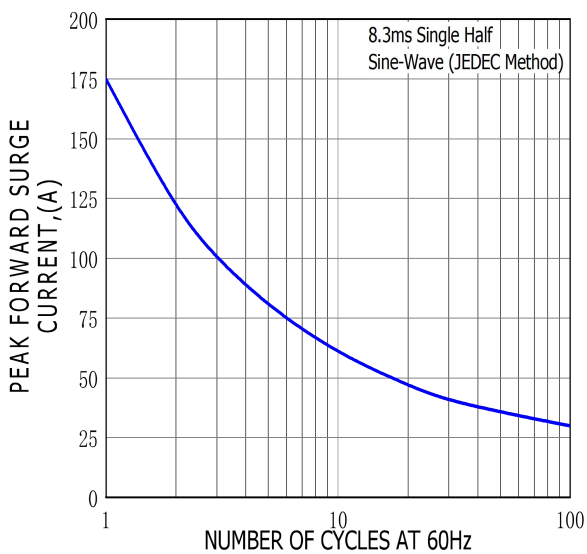
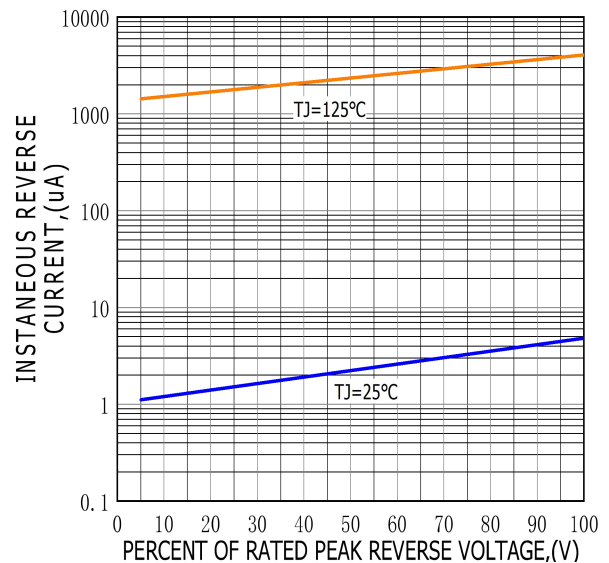

FIG.4-TYPICAL REVERSE CHARACTERISTICS



TO-262-3L PACKAGE OUTLINE



RECOMMENDED LAND PATTERN

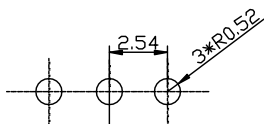

UNIT: mm

	MIN	NOM	MAX
A	4.50	4.70	4.90
A1	2.45	2.60	2.70
B	0.72	0.82	0.92
B1	1.12	1.27	1.42
c	0.28	0.38	0.48
c1	1.17	1.27	1.37
D	8.46	8.66	8.86
D1	7.90	8.10	8.40
D2	5.50	5.70	5.90
D3	7.10	7.30	7.50
E	9.85	10.15	10.45
e		2.54	
H	23.20	23.60	24.00
L	13.10	13.60	14.10
L1	3.85	4.05	4.35
L2	1.01	1.23	1.50