

## PS40U100CT&PS40U100FCT

### 40.0AMPS. SCHOTTKY BARRIER RECTIFIERS

#### FEATURE

- . High current capability
- . Ultra low forward voltage drop
- . Low power loss, high efficiency
- . High surge capability
- . High temperature soldering guaranteed  
260°C /10seconds, 0.25"(6.35mm)from case.

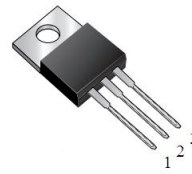

TO-220AB-3L  
PS40U100CT

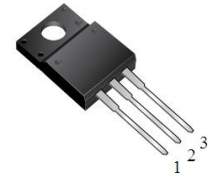

TO-220F-3L  
PS40U100FCT

#### MECHANICAL DATA

- . Case: Molded with UL-94 Class V-0 recognized  
Flame Retardant Epoxy
- . Mounting position: any

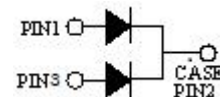

Single phase, half wave, 60Hz, resistive or inductive load.

For capacitive load, derate current by 20%

#### MAXIMUM RATINGS (T<sub>C</sub>=25°C unless otherwise noted)

Parameter	Symbol	PS40U100CT&PS40U100FCT	Units
Maximum Recurrent Peak Reverse Voltage	V <sub>RRM</sub>	100	V
Maximum RMS Voltage	V <sub>RMS</sub>	70	V
Maximum DC blocking Voltage	V <sub>DC</sub>	100	V
Maximum Average Forward Rectified Current <i>Per Leg</i> at T <sub>C</sub> =100°C <i>Total device</i>	I <sub>F(AV)</sub>	20.0 40.0	A
Peak Forward Surge Current 8.3ms single half sine-wave superimposed on rated load (JEDEC method) <i>Per Leg</i>	I <sub>FSM</sub>	200.0	A
Typical Junction Capacitance (Note 1)	C <sub>J</sub>	950	pF
Operation Junction Temperature and Storage Temperature	T <sub>J</sub> , T <sub>STG</sub>	-55 to +150	°C

#### ELECTRICAL CHARACTERISTICS-*Per Leg* (T<sub>C</sub>=25°C unless otherwise noted)

Parameter	Symbol	Test conditions	Typ	Max	Units	
Forward voltage drop	V <sub>F</sub>	T <sub>J</sub> =25°C	I <sub>F</sub> =3A	0.44	---	V
			I <sub>F</sub> =5A	0.48	---	
			I <sub>F</sub> =20A	0.73	0.85	
		T <sub>J</sub> =125°C	I <sub>F</sub> =3A	0.35	---	
			I <sub>F</sub> =5A	0.42	---	
			I <sub>F</sub> =20A	0.68	0.75	
Reverse leakage current	I <sub>R</sub>	T <sub>J</sub> =25°C	V <sub>R</sub> =100V	---	100	μA
		T <sub>J</sub> =125°C	V <sub>R</sub> =100V	---	15	mA

#### THERMAL CHARACTERISTICS(T<sub>C</sub>=25°C unless otherwise noted)

Parameter	Symbol	PS40U100CT	PS40U100FCT	Units
Typical Thermal Resistance (Note 2)	R <sub>(JC)</sub>	2.0	3.0	°C/W

#### Notes:

1. Measured at 1.0 MHz and applied reverse voltage of 4.0Vdc
2. Thermal Resistance from Junction to Case

RATING AND CHARACTERISTIC CURVES

FIG.1-TYPICAL FORWARD CURRENT DERATING CURVE

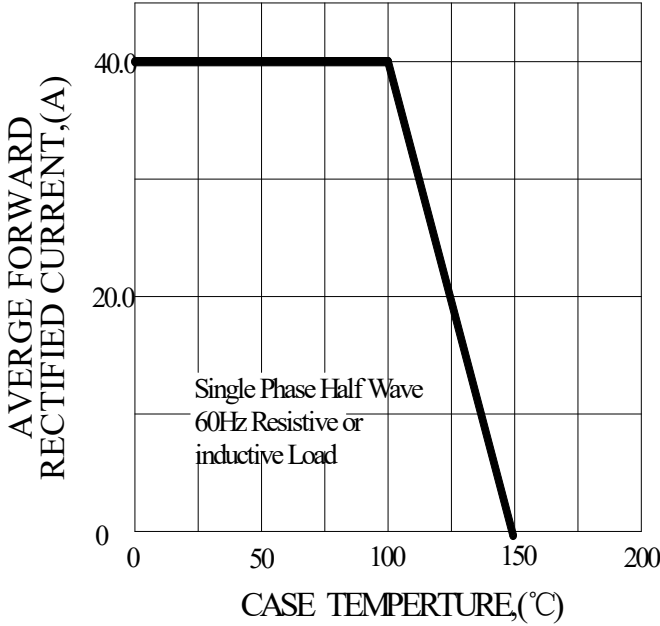

FIG.2-TYPICAL INSTANTANEOUS FORWARD CHARACTERISTICS

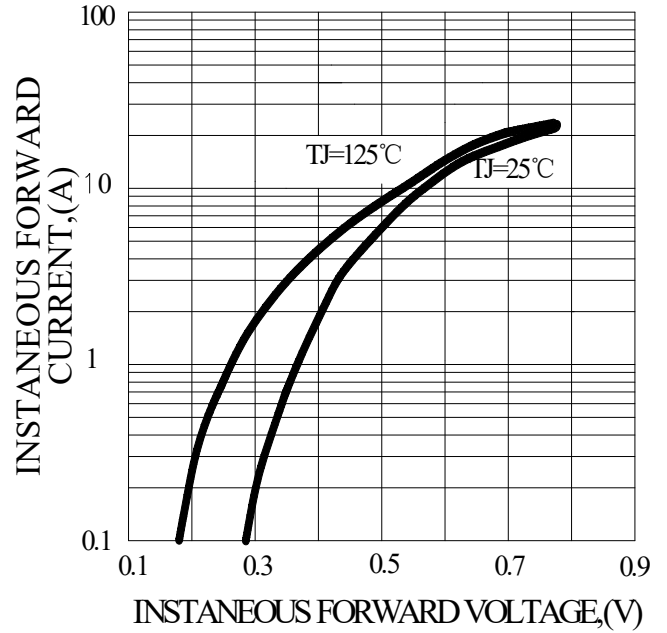

FIG.3-MAXIMUM NON-REPETITIVE FORWARD SURGE CURRENT

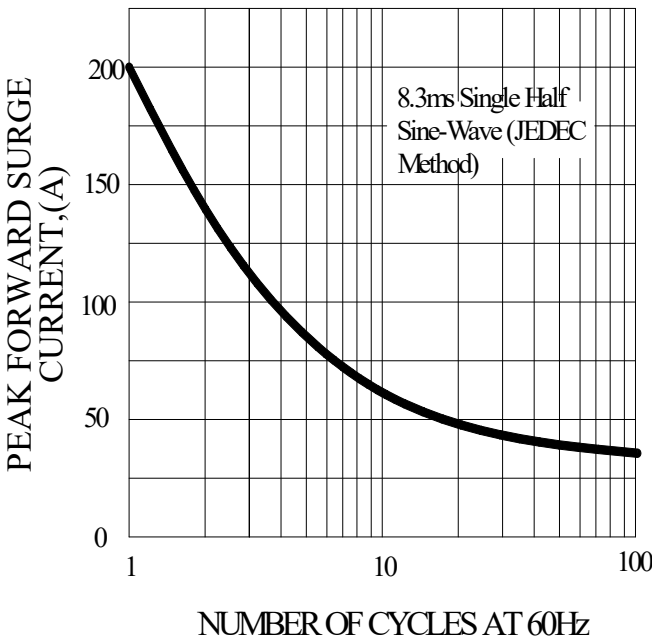
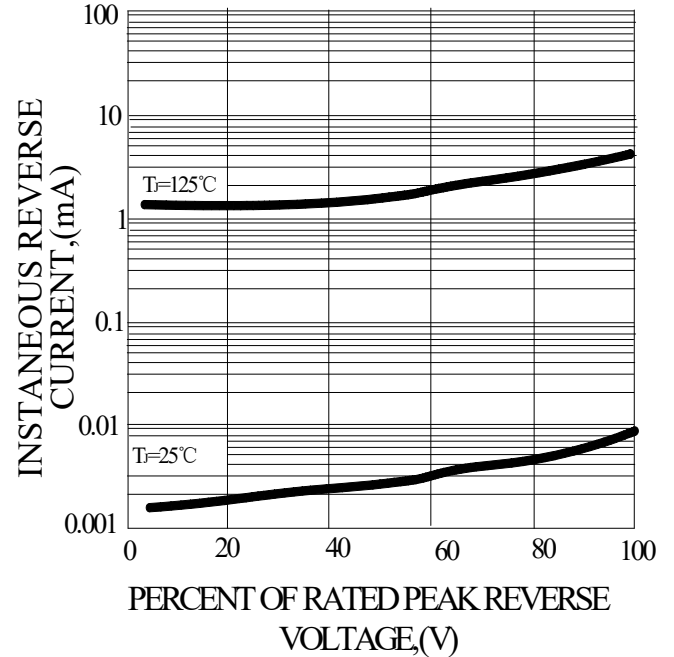
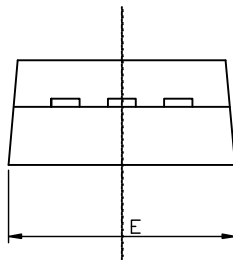
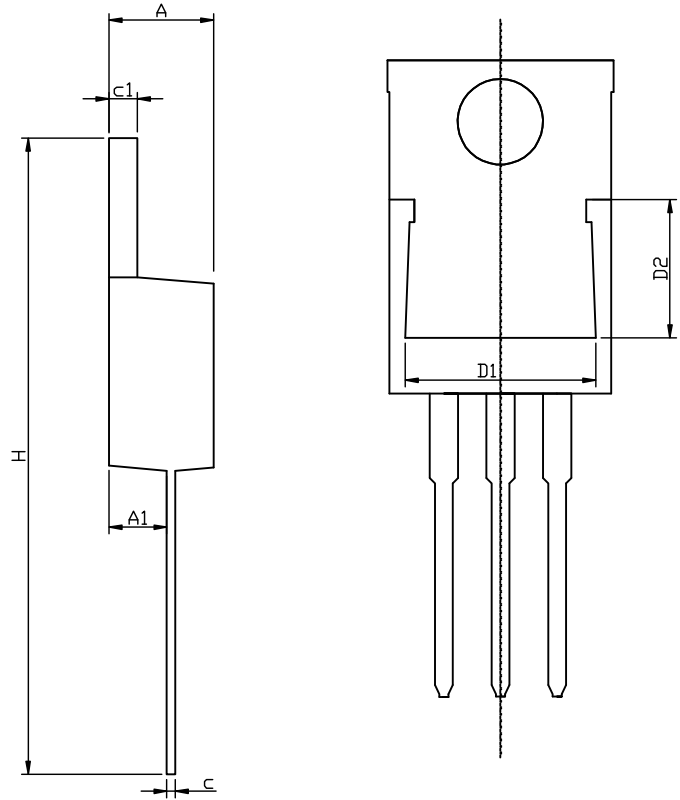
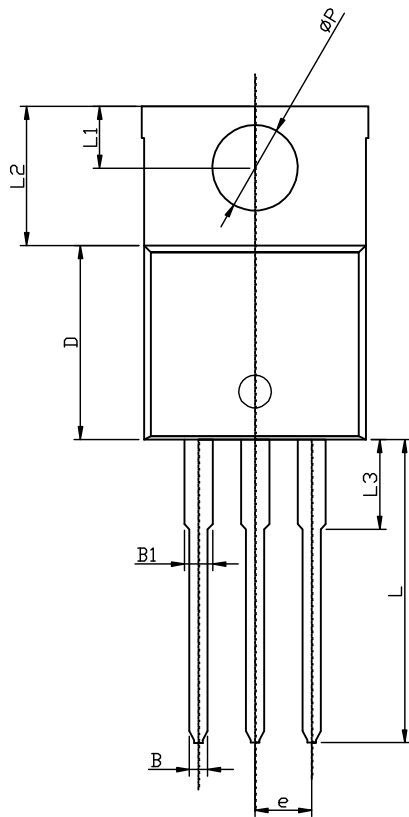

FIG.4-TYPICAL REVERSE CHARACTERISTICS



# TO-220AB-3L PACKAGE OUTLINE



RECOMMENDED LAND PATTERN

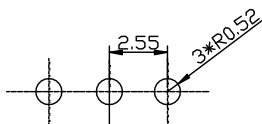

UNIT: mm

	MIN	NOM	MAX
A	4.50	4.70	4.90
A1	2.45	2.60	2.70
B	0.72	0.82	0.92
B1	1.12	1.27	1.42
c	0.28	0.38	0.48
c1	1.17	1.27	1.37
D	8.46	8.66	8.86
D1	7.90	8.10	8.40
D2	5.50	5.70	5.90
e	2.45	2.55	2.65
E	9.85	10.15	10.45
H	28.00	28.50	29.00
$\phi P$		3.84	
L	13.1	13.6	14.1
L1	2.54	2.74	2.94
L2	6.04	6.24	6.44
L3	3.85	4.05	4.35

# TO-220F-3L PACKAGE OUTLINE

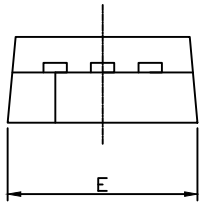
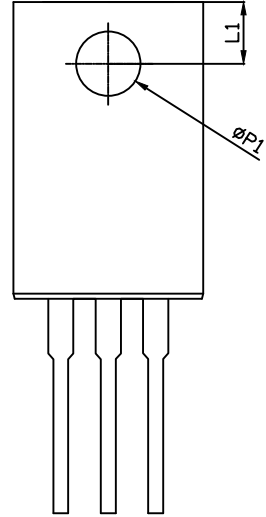
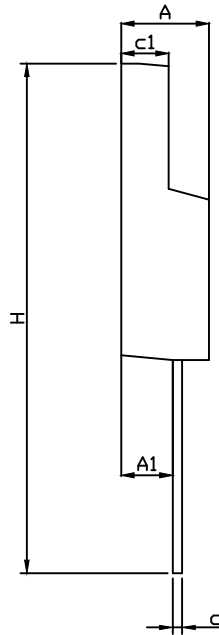
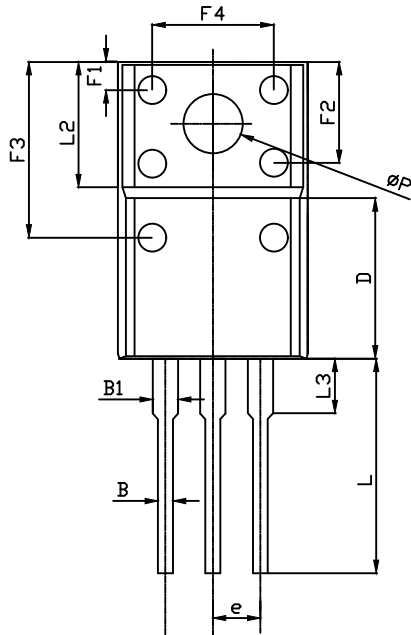

RECOMMENDED LAND PATTERN

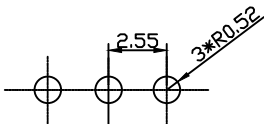

UNIT: mm

	MIN	NOM	MAX
A	4.40	4.60	4.80
A1	2.63	2.76	2.89
B	0.75	0.80	0.90
B1	1.12	1.27	1.42
c	0.40	0.50	0.60
c1	2.60	2.70	2.80
D	7.50	7.80	8.10
e	-	2.55REF	-
E	9.86	10.00	10.10
F1	1.90	2.12	2.40
F2	5.00	5.30	5.65
F3	8.70	9.00	9.30
F4	6.20	6.50	6.80
H	27.80	28.30	28.80
L	13.10	13.30	13.50
L1	2.85	3.00	3.15
L2	-	6.70REF	-
L3	3.10	3.60	4.10
<b>ΦP</b>	3.00	3.30	3.60
ΦP1	2.80	3.10	3.40