

## PW39K

### 20V P-Channel MOSFET

-0.66A -20V;  $R_{DS(ON)typ}=450m\Omega@-4.5V$ ,  $R_{DS(ON)typ}=650m\Omega@-2.5V$ ,  
 $R_{DS(ON)typ}=950m\Omega@-1.8V$

#### FEATURE

- Surface Mount Package
- P-Channel Switch with Low RDS(on)
- Operated at Low Logic Level Gate Drive
- ESD Protected

#### Application

- Load/Power Switching
- Interfacing, Logic Switching
- Battery Management for Ultra Small Portable Electronics

#### MARKING:

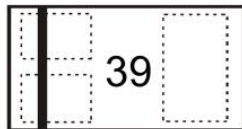

Top View  
Bar Denotes Gate  
and Source Side

#### DFN1006-3L



Bottom View

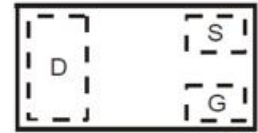

Top View  
Internal Schematic

#### Schematic diagram

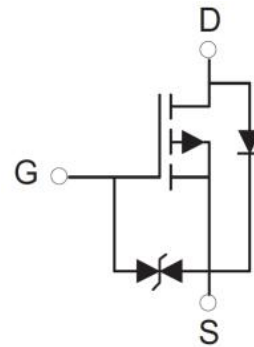

#### ABSOLUTE MAXIMUM RATINGS ( $T_a=25^\circ\text{C}$ unless otherwise noted)

Parameter	Symbol	Value	Unit
Drain-Source Voltage	$V_{DS}$	-20	V
Gate-Source Voltage	$V_{GS}$	$\pm 12$	V
Continuous Drain Current <sup>(1)</sup>	$I_D$	-0.66	A
Pulsed Drain Current( $t_p=10\mu\text{s}$ )	$I_{DM}$	-1.2	A
Power Dissipation <sup>(1)</sup>	$P_D$	100	mW
Thermal Resistance from Junction to Ambient <sup>(1)</sup>	$R_{\theta JA}$	1250	$^\circ\text{C}/\text{W}$
Junction Temperature	$T_J$	150	$^\circ\text{C}$
Storage Temperature	$T_{STG}$	-55~ +150	$^\circ\text{C}$
Lead Temperature for Soldering Purposes(1/8" from case for 10s)	TL	260	$^\circ\text{C}$

**MOSFET ELECTRICAL CHARACTERISTICS(T<sub>a</sub>=25°C unless otherwise noted)**

Parameter	Symbol	Test Condition	Min	Type	Max	Unit
<b>Stat Characteristics</b>						
Drain-source breakdown voltage	V <sub>(BR)DSS</sub>	V <sub>GS</sub> = 0V, I <sub>D</sub> = -250μA	-20			V
Zero gate voltage drain current	I <sub>DSS</sub>	V <sub>DS</sub> = -20V, V <sub>GS</sub> = 0V			-1	μA
Gate-body leakage current	I <sub>GSS</sub>	V <sub>GS</sub> = ±10V, V <sub>DS</sub> = 0V			±20	μA
Gate threshold voltage <sup>(2)</sup>	V <sub>GS(th)</sub>	V <sub>DS</sub> = V <sub>GS</sub> , I <sub>D</sub> = -250μA	-0.35	-0.61	-1.1	V
Drain-source on-resistance <sup>(2)</sup>	R <sub>DS(on)</sub>	V <sub>GS</sub> = -4.5V, I <sub>D</sub> = -1A		450	580	mΩ
		V <sub>GS</sub> = -2.5V, I <sub>D</sub> = -0.8A		650	840	
		V <sub>GS</sub> = -1.8V, I <sub>D</sub> = -0.5A		950		
Forward tranconductance <sup>(2)</sup>	g <sub>FS</sub>	V <sub>DS</sub> = -10V, I <sub>D</sub> = -0.54A		1.2		S
<b>Dynamic characteristics<sup>(4)</sup></b>						
Input Capacitance	C <sub>iss</sub>	V <sub>DS</sub> = -16V, V <sub>GS</sub> = 0V, f = 1MHz		113		pF
Output Capacitance	C <sub>oss</sub>			15		
Reverse Transfer Capacitance	C <sub>rss</sub>			9		
<b>Switching characteristics<sup>(4)</sup></b>						
Turn-on delay time <sup>(3)</sup>	t <sub>d(on)</sub>	V <sub>DD</sub> = -10V, V <sub>GS</sub> = -4.5V, I <sub>D</sub> = -200mA, R <sub>G</sub> = 10Ω		9		ns
Turn-on rise time <sup>(3)</sup>	t <sub>r</sub>			5.7		
Turn-off delay time <sup>(3)</sup>	t <sub>d(off)</sub>			32.6		
Turn-off fall time <sup>(3)</sup>	t <sub>f</sub>			20.3		
<b>Source-Drain Diode characteristics</b>						
Diode Forward voltage	V <sub>DS</sub>	I <sub>S</sub> = -0.5A, V <sub>GS</sub> = 0V			-1.2	V

**Notes:**

1. Surface mounted on FR4 board using the minimum recommended pad size.
2. Pulse Test : Pulse Width=300μs, Duty Cycle=2%.
3. Switching characteristics are independent of operating junction temperatures.
4. Guaranteed by design, not subject to producing.

**Typical Electrical and Thermal Characteristics**

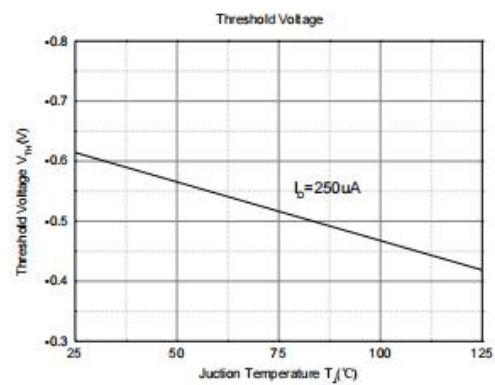
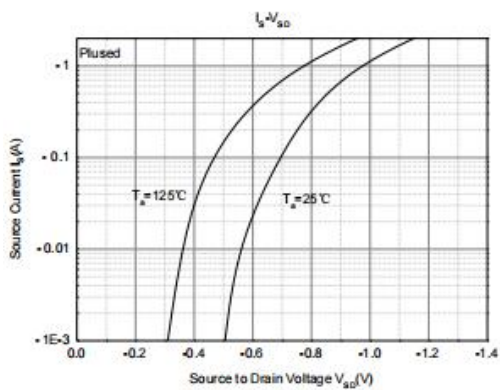
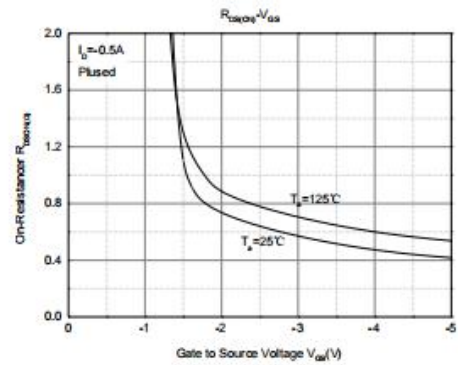
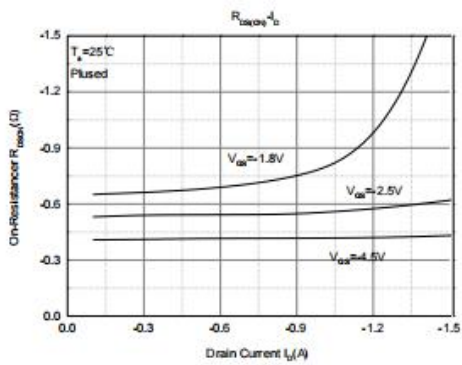
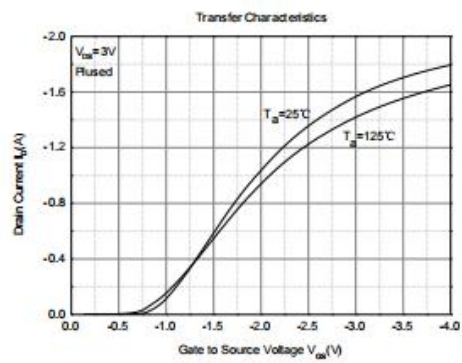
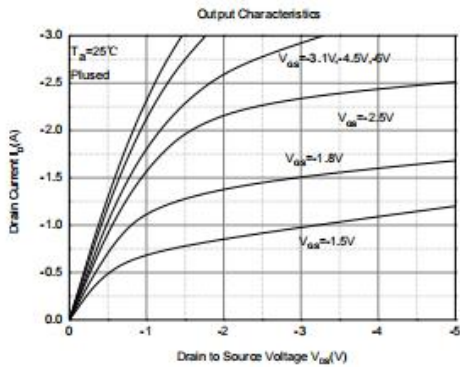

**DFN1006-3L Package Information**

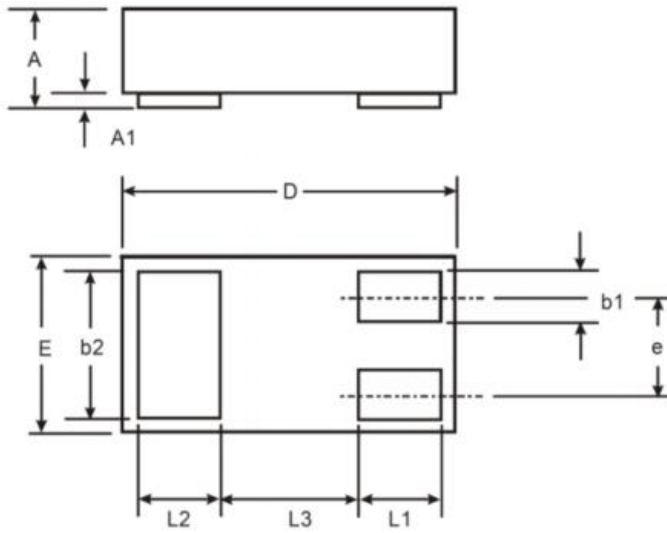

X1-DFN1006-3			
Dim	Min	Max	Typ
A	0.47	0.53	0.50
A1	0	0.05	0.03
b1	0.10	0.20	0.15
b2	0.45	0.55	0.50
D	0.95	1.075	1.00
E	0.55	0.675	0.60
e	—	—	0.35
L1	0.20	0.30	0.25
L2	0.20	0.30	0.25
L3	—	—	0.40
All Dimensions in mm			

DFN1006-3L Tape and Reel

DFN1006-3L Embossed Carrier Tape

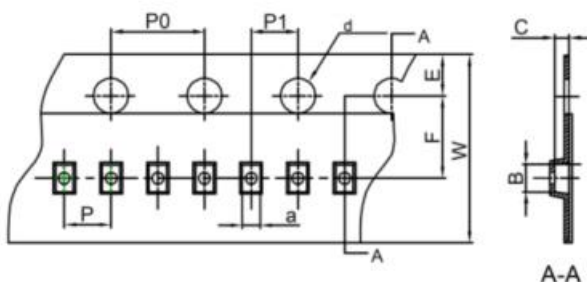

Dimensions are in millimeter										
Pkg type	A	B	C	d	E	F	P0	P	P1	W
DFN1006-3L	0.66	1.15	0.66	Ø1.50	1.75	3.50	4.00	2.00	2.00	8.00

DFN1006-3L Tape Leader and Trailer

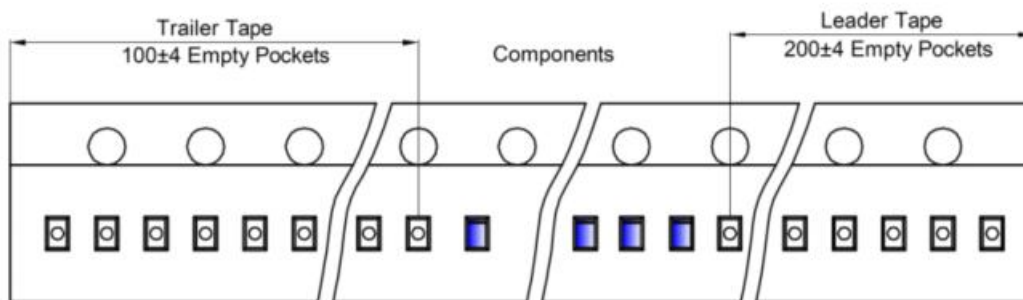

DFN1006-3L Reel

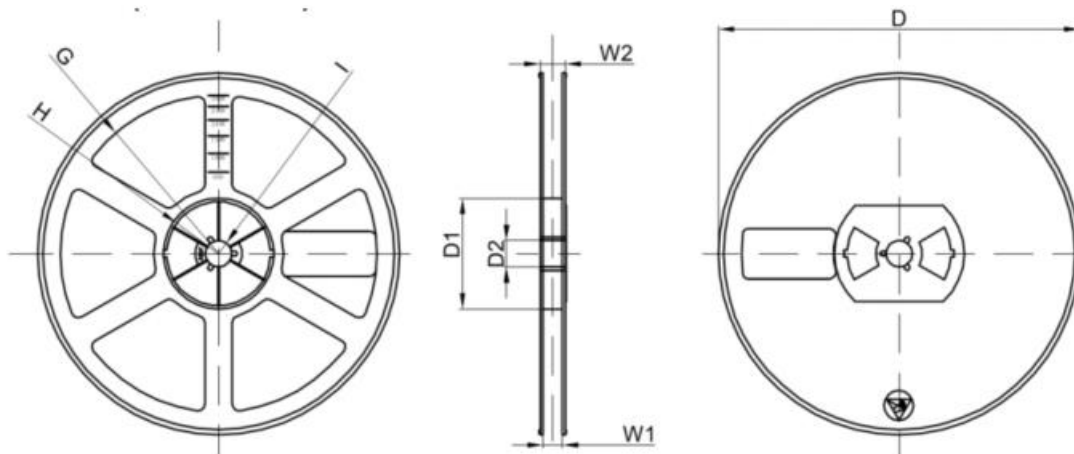

Dimensions are in millimeter								
Reel Option	D	D1	D2	G	H	I	W1	W2
7" Dia	Ø178.00	54.40	13.00	R78.00	R25.60	R6.50	9.50	12.30

REEL	Reel Size	Box	Box Size(mm)	Carton	Carton Size(mm)	G.W.(kg)
10000 pcs	7 inch	100,000 pcs	203×203×195	400,000 pcs	438×438×220	