

PWK2009

20V P-Channel MOSFET

-9A -20V; $R_{DS(ON)typ}=16m\Omega@-4.5V$, $R_{DS(ON)typ}=27m\Omega@-2.5V$,

FEATURE

- Advanced trench MOSFET process technology
- Ultra low on-resistance with low gate charge

Application

- PWM application
- Load switch
- Battery charge in cellular handset

MARKING:

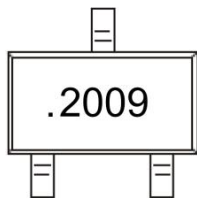

SOT-23-3L

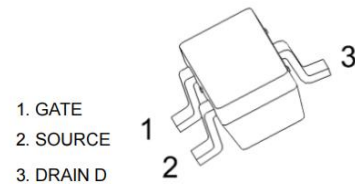

Schematic diagram

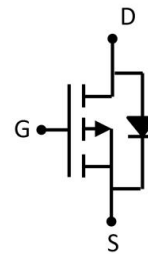

ABSOLUTE MAXIMUM RATINGS ($T_a=25^{\circ}C$ unless otherwise noted)

Parameter	Symbol	Value	Unit
Drain-Source Voltage	V_{DS}	-20	V
Gate-Source Voltage	V_{GS}	± 12	V
Continuous Drain Current	I_D	-9	A
Pulsed Drain Current ¹	I_{DM}	-36	A
Power Dissipation	P_D	0.45	W
Thermal Resistance from Junction to Ambient	$R_{\theta JA}$	278	$^{\circ}C/W$
Junction Temperature	T_J	150	$^{\circ}C$
Storage Temperature	T_{STG}	-55~ +150	$^{\circ}C$

MOSFET ELECTRICAL CHARACTERISTICS(T_a=25°C unless otherwise noted)

Parameter	Symbol	Test Condition	Min	Type	Max	Unit
STATIC CHARACTERISTICS						
Drain-source breakdown voltage	V _{(BR)DSS}	V _{GS} = 0V, I _D = -250μA	-20			V
Zero gate voltage drain current	I _{DSS}	V _{DS} = -20V, V _{GS} = 0V			-1	μA
Gate-body leakage current	I _{GSS}	V _{GS} = ±12V, V _{DS} = 0V			±100	nA
Gate threshold voltage ³	V _{GS(th)}	V _{DS} = V _{GS} , I _D = -250μA	-0.5	-0.9	-1.2	V
Drain-source on-resistance ³	R _{DS(on)}	V _{GS} = -4.5V, I _D = -6A		16	21	mΩ
		V _{GS} = -2.5V, I _D = -6A		27	38	
Forward tranconductance ³	g _{FS}	V _{DS} = -5V, I _D = -6A	9	17		S
DYNAMIC CHARACTERISTICS⁴						
Input Capacitance	C _{iss}	V _{DS} = -10V, V _{GS} = 0V, f = 1MHz		2700		pF
Output Capacitance	C _{oss}			680		
Reverse Transfer Capacitance	C _{rss}			590		
Total Gate Charge	Q _g	V _{DS} = -6V, V _{GS} = -4.5V, I _D = -10A		35	48	nC
Gate-Source Charge	Q _{gs}			5		
Gate-Drain Charge	Q _{gd}			10		
Turn-on delay time	t _{d(on)}	V _{DD} = -10V, V _{GEN} = -4.5V, I _D = -1A R _g = 10Ω		11		nS
Turn-on rise time	t _r			35		
Turn-off delay time	t _{d(off)}			30		
Turn-off fall time	t _f			10		
SOURCE-DRAIN DIODE CHARACTERISTICS						
Diode Forward Current	I _s				-9	A
Diode Forward voltage ³	V _{DS}	V _{GS} = 0V, I _S = -2A		-0.75	-1.2	V

Notes :

- 1.Repetitive Rating: Pulse width limited by maximum junction temperature.
- 2.This test is performed with no heat sink at T_a=25°C.
- 3.Pulse Test: Pulse With ≤300 μ s,Duty Cycle≤2%.
- 4.Guaranteed by design, not subject to production testing.

Typical Electrical and Thermal Characteristics

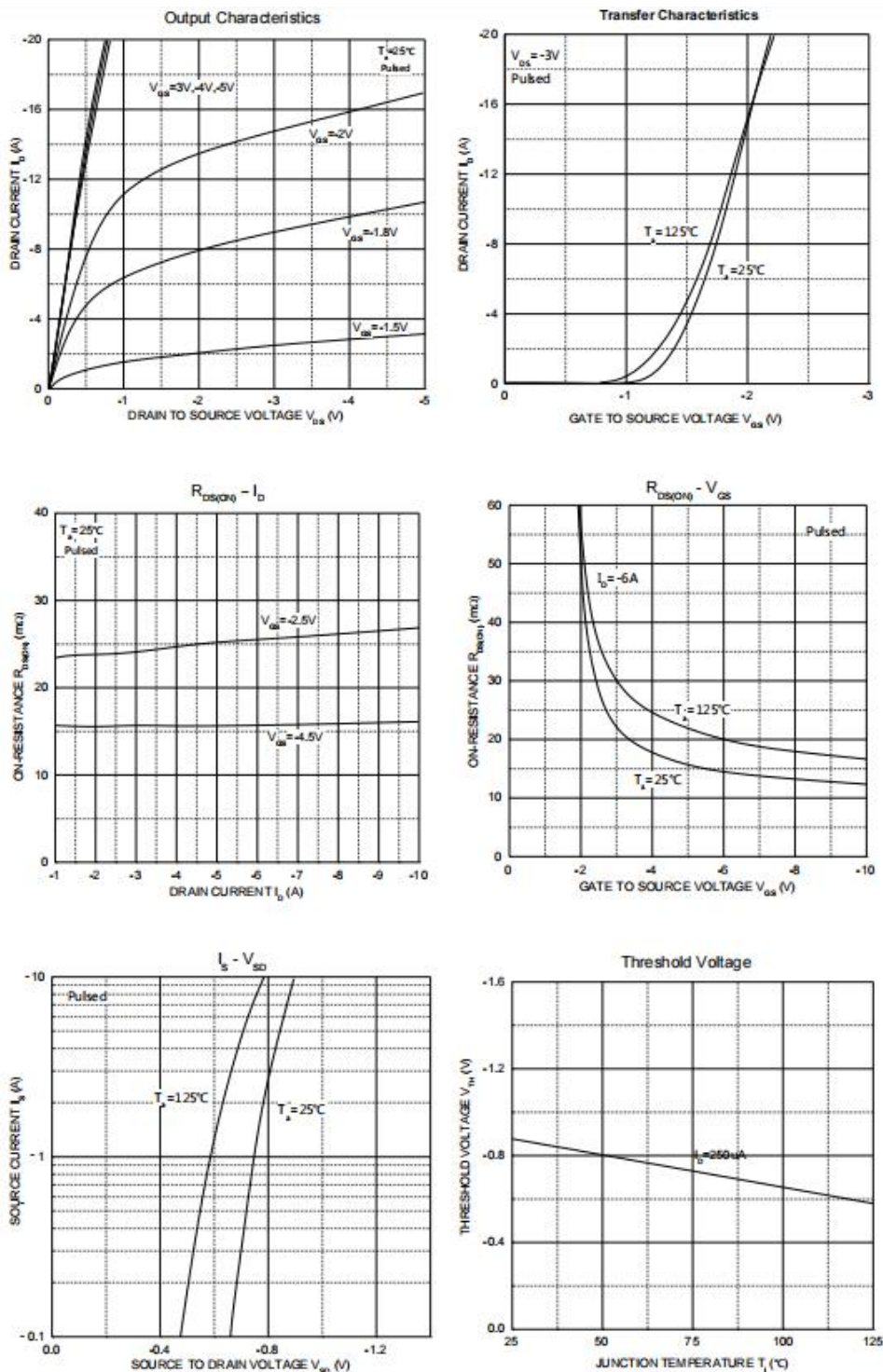

SOT-23-3L Package Information

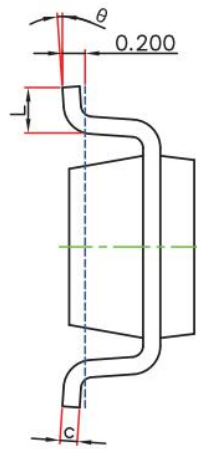
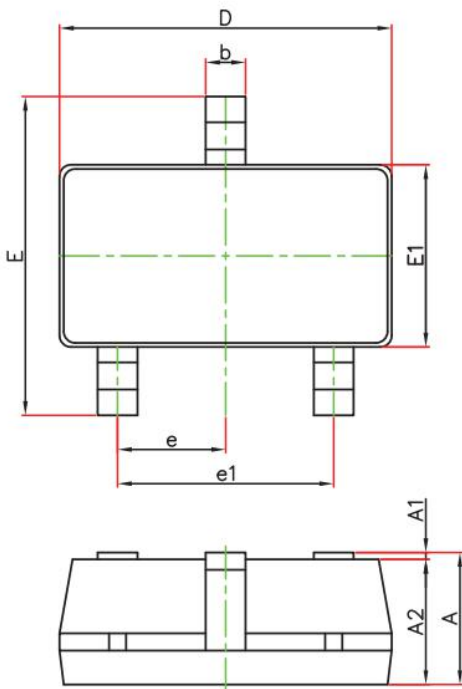

Symbol	Dimensions In Millimeters		Dimensions In Inches	
	Min.	Max.	Min.	Max.
A	1.050	1.250	0.041	0.049
A1	0.000	0.100	0.000	0.004
A2	1.050	1.150	0.041	0.045
b	0.300	0.500	0.012	0.020
c	0.100	0.200	0.004	0.008
D	2.820	3.020	0.111	0.119
E1	1.500	1.700	0.059	0.067
E	2.650	2.950	0.104	0.116
e	0.950(BSC)		0.037(BSC)	
e1	1.800	2.000	0.071	0.079
L	0.300	0.600	0.012	0.024
θ	0°	8°	0°	8°

SOT-23-3L Tape and Reel

SOT-23-3L Embossed Carrier Tape

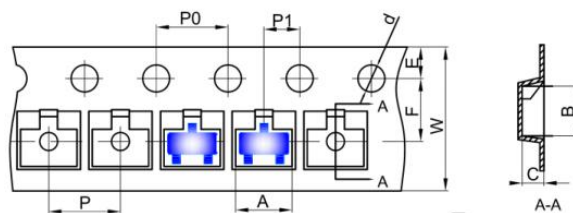

Dimensions are in millimeter										
Pkg type	A	B	C	d	E	F	P0	P	P1	W
SOT-23-3L	3.18	3.28	1.32	Ø1.55	1.75	3.50	4.00	4.00	2.00	8.00

SOT-23-3L Tape Leader and Trailer

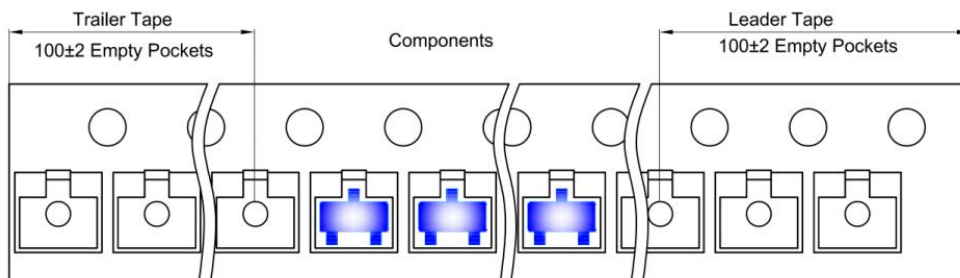

SOT-23-3L Reel

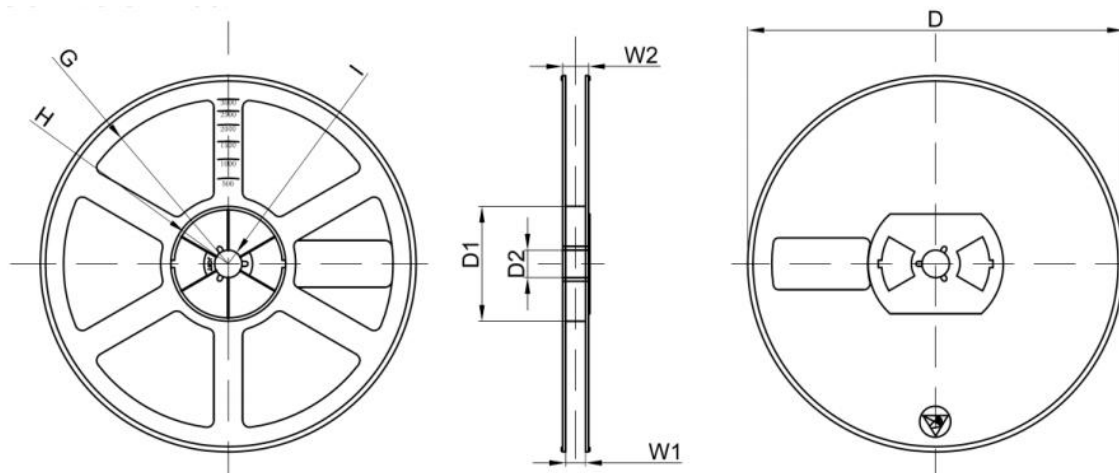

Dimensions are in millimeter								
Reel Option	D	D1	D2	G	H	I	W1	W2
7" Dia	Ø180.00	60.00	13.00	R78.00	R25.60	R6.50	9.50	13.10

REEL	Reel Size	Box	Box Size(mm)	Carton	Carton Size(mm)	G.W.(kg)
3000 pcs	7 inch	30,000 pcs	203×203×195	120,000 pcs	438×438×220	