

PWK3415

20V P-Channel MOSFET

-4A -20V; $R_{DS(ON)typ}=33m\Omega@-4.5V$, $R_{DS(ON)typ}=45m\Omega@-2.5V$,
 $R_{DS(ON)typ}=63m\Omega@-1.8V$

FEATURE

- Excellent $R_{DS(ON)}$, low gate charge, low gate voltages
- TrenchFET power MOSFET
- ESD protected gate

Application

- Load switch and in PWM applications

MARKING:

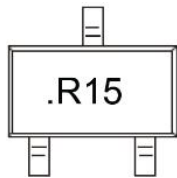

SOT-23-3L

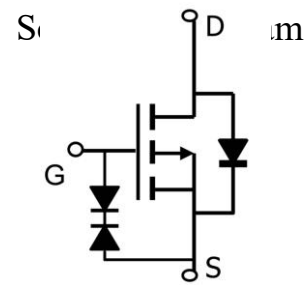
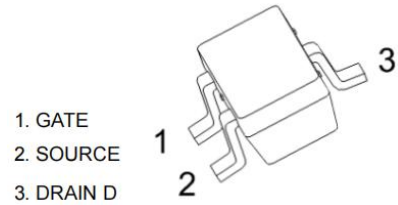

ABSOLUTE MAXIMUM RATINGS ($T_a=25^\circ\text{C}$ unless otherwise noted)

Parameter	Symbol	Value	Unit
Drain-Source Voltage	V_{DS}	-20	V
Gate-Source Voltage	V_{GS}	± 8	V
Continuous Drain Current ($t \leq 10s$)	I_D	-4.0	A
Maximum Power Dissipation ($t \leq 10s$)	P_D	0.3	W
Thermal Resistance from Junction to Ambient	$R_{\theta JA}$	417	$^\circ\text{C/W}$
Junction Temperature	T_J	150	$^\circ\text{C}$
Storage Temperature	T_{STG}	-55~+150	$^\circ\text{C}$

MOSFET ELECTRICAL CHARACTERISTICS(T_a=25°C unless otherwise noted)

Parameter	Symbol	Test Condition	Min	Type	Max	Unit
STATIC CHARACTERISTICS						
Drain-source breakdown voltage	V _{(BR)DSS}	V _{GS} = 0V, I _D = -250μA	-20			V
Zero gate voltage drain current	I _{DSS}	V _{DS} = -16V, V _{GS} = 0V			-1	μA
Gate-body leakage current	I _{GSS}	V _{GS} = ±8V, V _{DS} = 0V			±10	μA
Gate threshold voltage	V _{GS(th)}	V _{DS} = V _{GS} , I _D = -250μA	-0.3	-0.65	-1.0	V
Drain-source on-resistance ⁽¹⁾	R _{DS(on)}	V _{GS} = -4.5V, I _D = -4A		33	43	mΩ
		V _{GS} = -2.5V, I _D = -4A		45	60	
		V _{GS} = -1.8V, I _D = -2A		63	90	
Forward transconductance ⁽²⁾	g _{FS}	V _{DS} = -5V, I _D = -4A	8			S
DYNAMIC CHARACTERISTICS⁽³⁾						
Input Capacitance	C _{iss}	V _{DS} = -10V, V _{GS} = 0V, f = 1MHz		1450		pF
Output Capacitance	C _{oss}			205		
Reverse Transfer Capacitance	C _{rss}			160		
Gate resistance	R _g	V _{DS} = 0V, V _{GS} = 0V, f = 1MHz		6.5		Ω
SWITCHING CHARACTERISTICS⁽⁴⁾						
Turn-on delay time ⁽³⁾	t _{d(on)}	V _{DS} = -10V, V _{GS} = -4.5V R _{GEN} = 3Ω, R _L = 2.5Ω,		9.5		ns
Turn-on rise time ⁽³⁾	t _r			17		
Turn-off delay time ⁽³⁾	t _{d(off)}			94		
Turn-off fall time ⁽³⁾	t _f			35		
Total gate charge	Q _g	V _{DS} = -10V, V _{GS} = -4.5V, I _D = -4A		17.2		nC
Gate-source charge	Q _{gs}			1.3		
Gate-drain charge	Q _{gd}			4.5		
SOURCE-DRAIN DIODE CHARACTERISTICS						
Diode Forward voltage ⁽²⁾	V _{DS}	I _S = 0.15A, V _{GS} = 0V			1.2	V

Notes:

- 1.Repetitive rating,pulse width limited by junction temperature.
- 2.Pulse Test : Pulse width ≦ 300μs, duty cycle ≦ 2%.
- 3.These parameters have no way to verify.

Typical Electrical and Thermal Characteristics

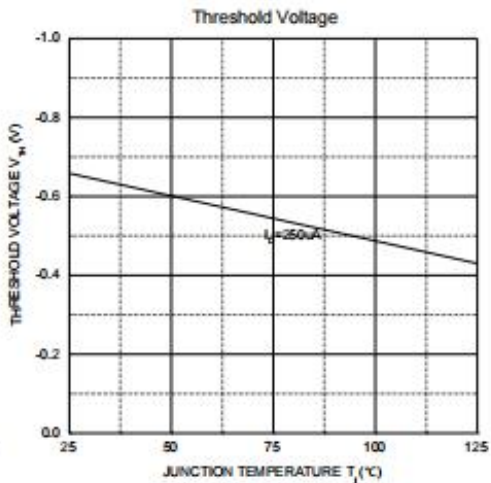
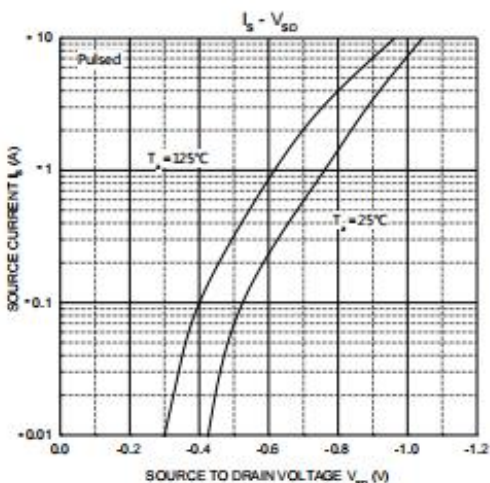
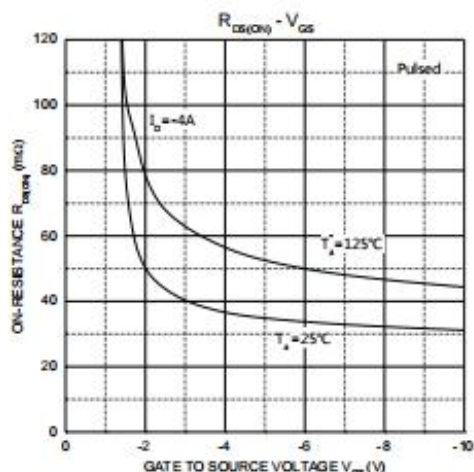
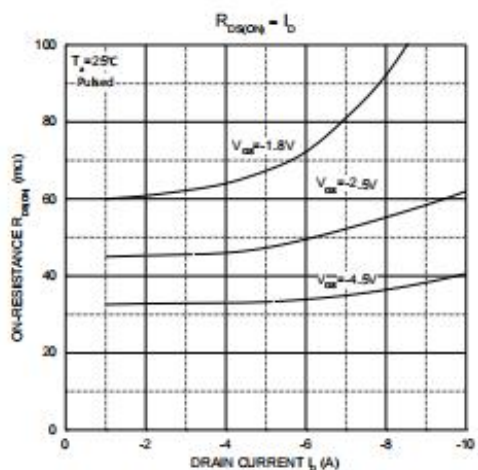
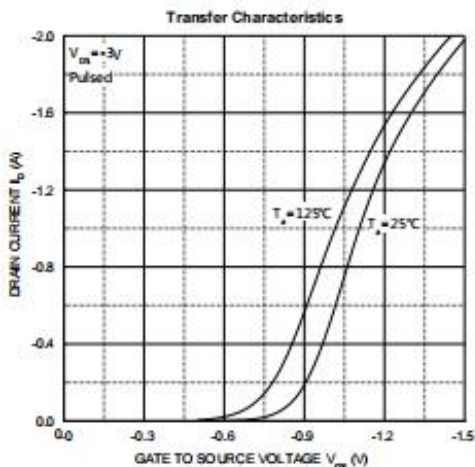
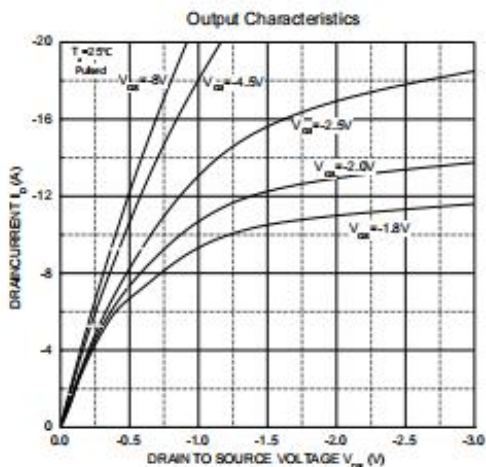

SOT-23-3L Package Information

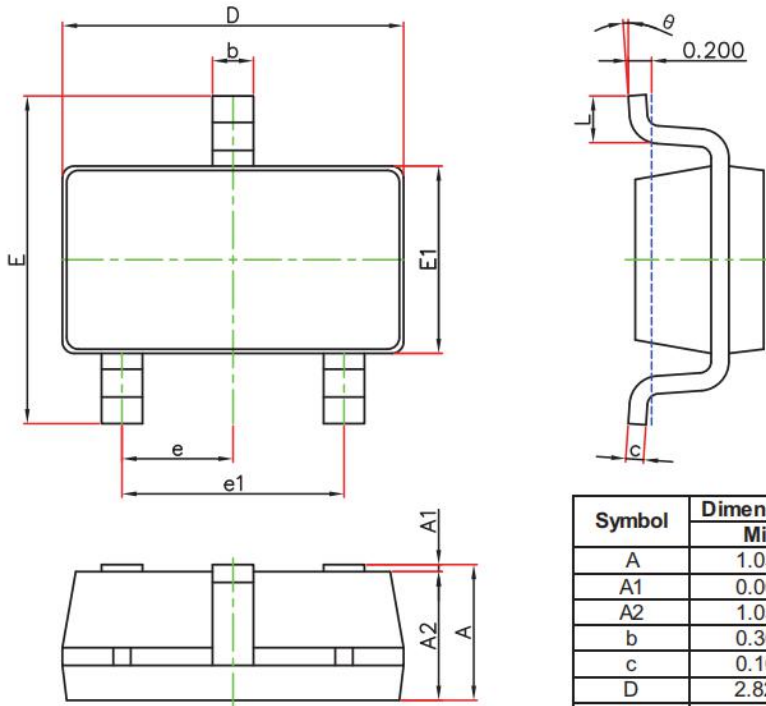

Symbol	Dimensions In Millimeters		Dimensions In Inches	
	Min.	Max.	Min.	Max.
A	1.050	1.250	0.041	0.049
A1	0.000	0.100	0.000	0.004
A2	1.050	1.150	0.041	0.045
b	0.300	0.500	0.012	0.020
c	0.100	0.200	0.004	0.008
D	2.820	3.020	0.111	0.119
E1	1.500	1.700	0.059	0.067
E	2.650	2.950	0.104	0.116
e	0.950(BSC)		0.037(BSC)	
e1	1.800	2.000	0.071	0.079
L	0.300	0.600	0.012	0.024
θ	0°	8°	0°	8°

SOT-23-3L Tape and Reel

SOT-23-3L Embossed Carrier Tape

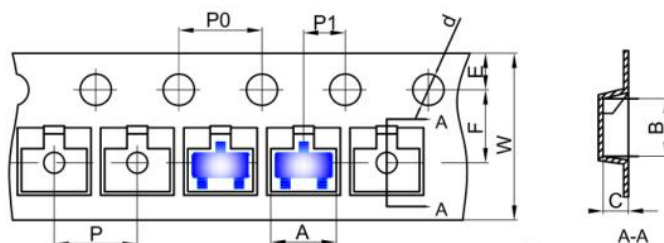

Dimensions are in millimeter										
Pkg type	A	B	C	d	E	F	P0	P	P1	W
SOT-23-3L	3.18	3.28	1.32	Ø1.50	1.75	3.50	4.00	4.00	2.00	8.00

SOT-23-3L Tape Leader and Trailer

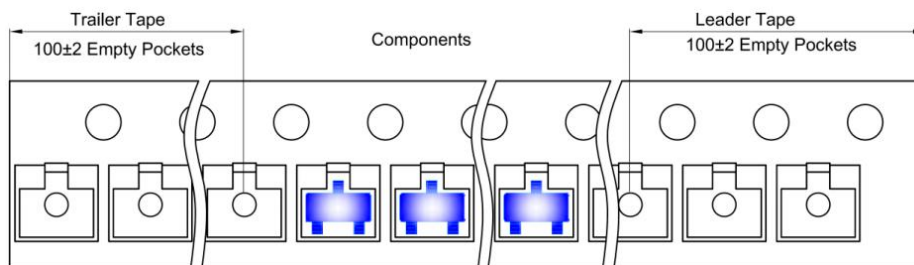

SOT-23-3L Reel

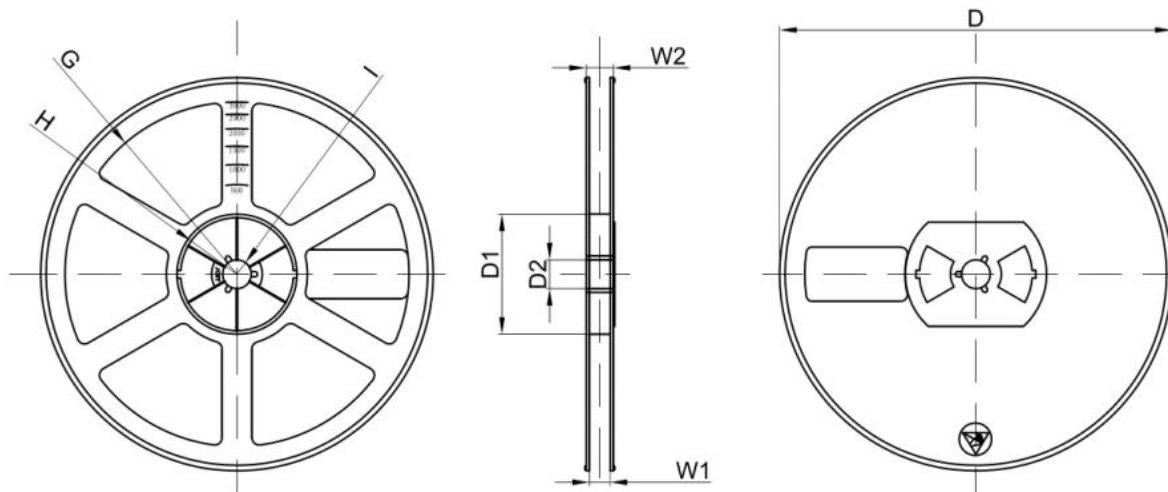

Dimensions are in millimeter								
Reel Option	D	D1	D2	G	H	I	W1	W2
7" Dia	Ø180.00	60.00	13.00	R78.00	R25.60	R6.50	9.50	13.10

REEL	Reel Size	Box	Box Size(mm)	Carton	Carton Size(mm)	G.W.(kg)
3000 pcs	7 inch	30,000 pcs	203×203×195	120,000 pcs	438×438×220	