

PW2321

20V P-Channel MOSFET

-4A -20V; $R_{DS(ON)typ}=35m\Omega@-4.5V$, $R_{DS(ON)typ}=49m\Omega@-2.5V$,
 $R_{DS(ON)typ}=74m\Omega@-1.8V$

FEATURE

- TrenchFET Power MOSFET

Application

- PA Switch
- Load Switch

MARKING:

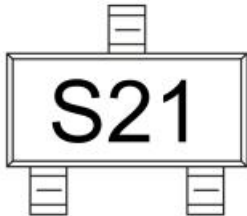

SOT-23

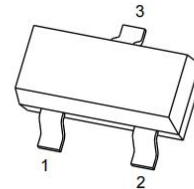

1. GATE
2. SOURCE
3. DRAIN

Schematic diagram

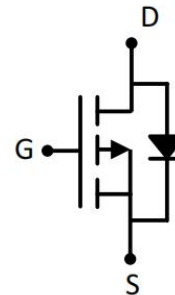

ABSOLUTE MAXIMUM RATINGS ($T_a=25^{\circ}C$ unless otherwise noted)

Parameter	Symbol	Value	Unit
Drain-Source Voltage	V_{DS}	-20	V
Gate-Source Voltage	V_{GS}	± 12	V
Continuous Drain Current	I_D	-4	A
Pulsed Drain Current	I_{DM}	-12	A
Continuous Drain Current	I_S	-0.59	A
Power Dissipation	P_D	0.35	W
Thermal Resistance from Junction to Ambient	$R_{\theta JA}$	357	$^{\circ}C/W$
Junction Temperature	T_J	150	$^{\circ}C$
Storage Temperature	T_{STG}	-55~ +150	$^{\circ}C$

MOSFET ELECTRICAL CHARACTERISTICS(T_a=25°C unless otherwise noted)

Parameter	Symbol	Test Condition	Min	Type	Max	Unit
Static Characteristics						
Drain-source breakdown voltage	V _{(BR)DSS}	V _{GS} = 0V, I _D = -250μA	-20			V
Zero gate voltage drain current	I _{DSS}	V _{DS} = -16V, V _{GS} = 0V			-1	μA
Gate-body leakage current	I _{GSS}	V _{GS} = ±12V, V _{DS} = 0V			±100	nA
Gate threshold voltage	V _{GS(th)}	V _{DS} = V _{GS} , I _D = -250μA	-0.4	-0.7	-1	V
Drain-source on-resistance	R _{DS(on)}	V _{GS} = -4.5V, I _D = -3.3A		35	45	mΩ
		V _{GS} = -2.5V, I _D = -2.8A		49	65	
		V _{GS} = -1.8V, I _D = -2.3A		74	110	
Forward tranconductance	g _{FS}	V _{DS} = -5V, I _D = -3.3A	3			S
Dynamic characteristics						
Input Capacitance ^(a,b)	C _{iss}	V _{DS} = -6V, V _{GS} = 0V, f = 1MHz		715		pF
Output Capacitance ^(a,b)	C _{oss}			170		
Reverse Transfer Capacitance ^(a,b)	C _{rss}			120		
Total gate charge ^(a)	Q _g	V _{DS} = -6V, V _{GS} = -4.5V, I _D = -3.3A			13	nC
Gate-source charge ^(a)	Q _{gs}			1.2		
Gate-drain charge ^(a)	Q _{gd}			1.6		
Switching^(a,b)						
Turn-on delay time	t _{d(on)}	V _{DD} = -6V, V _{GEN} = -4.5V, I _D = -1.0A, R _L = 6Ω, R _G = 6Ω			25	ns
Turn-on rise time	t _r				55	
Turn-off delay time	t _{d(off)}				90	
Turn-off fall time	t _f				60	
Source-Drain Diode characteristics						
Diode Forward voltage	V _{DS}	I _S = -1.6A, V _{GS} = 0V			-1.2	V

Notes:

- a. Pulse Test ;Pulse Width ≤300μs, Duty Cycle ≤2%.
 b. These parameters have no way to verify.

Typical Electrical and Thermal Characteristics

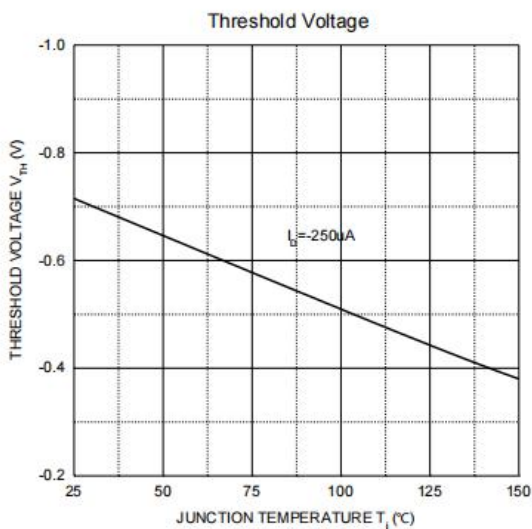
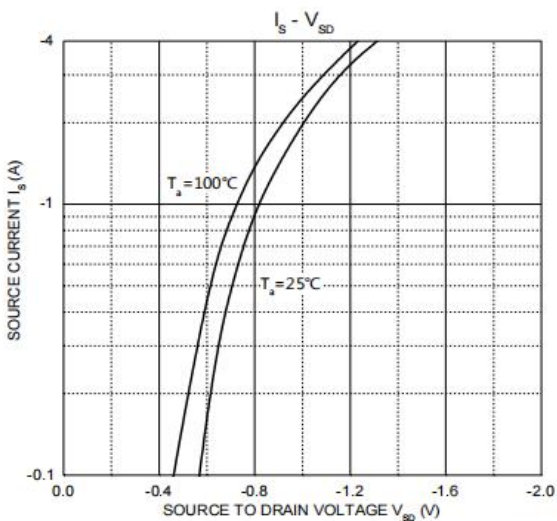
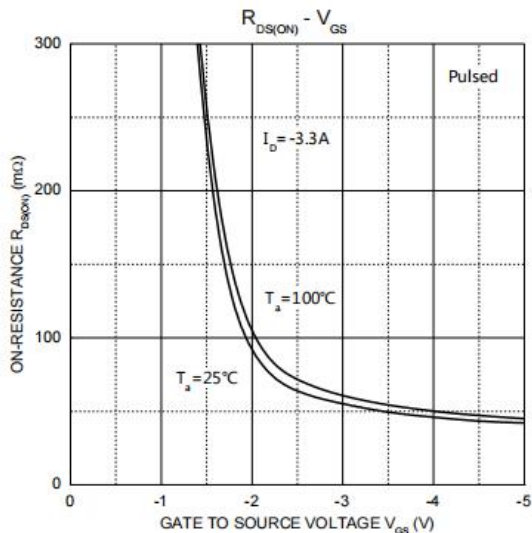
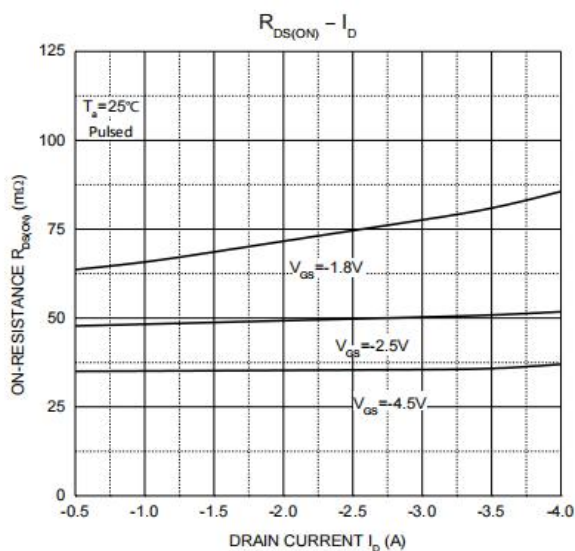
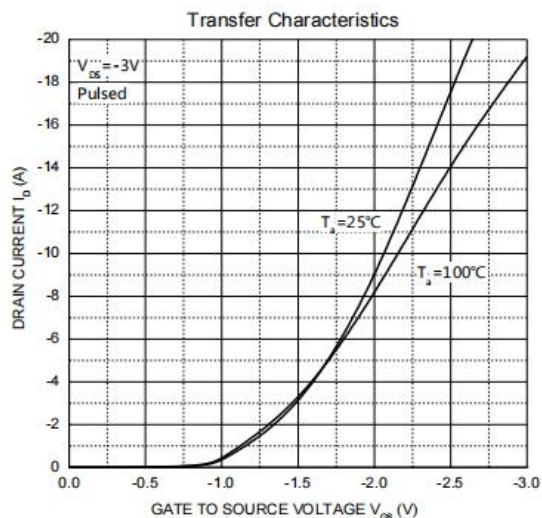
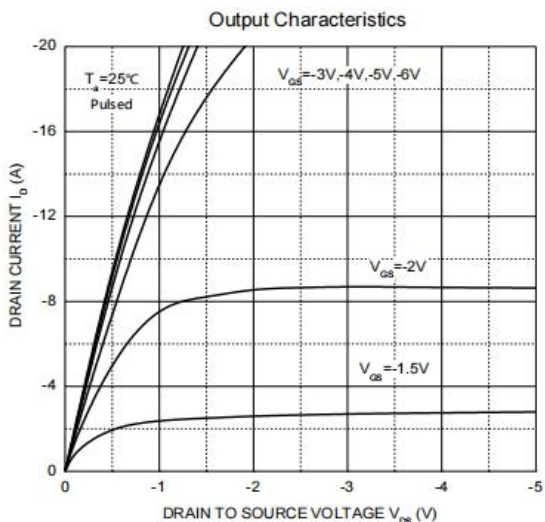

SOT-23 Package Information

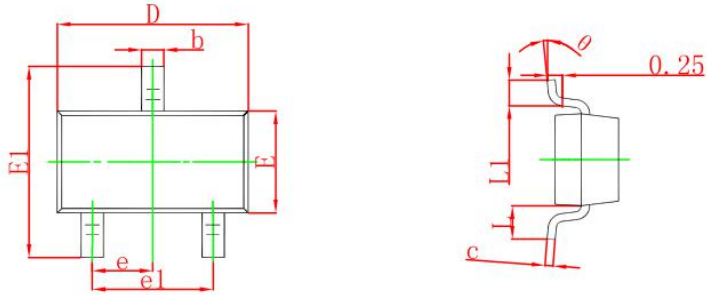

Symbol	Dimensions in Millimeters		Dimensions in Inches	
	Min	Max	Min	Max
A	0.900	1.150	0.035	0.045
A1	0.000	0.100	0.000	0.004
A2	0.900	1.050	0.035	0.041
b	0.300	0.500	0.012	0.020
c	0.080	0.150	0.003	0.006
D	2.800	3.000	0.110	0.118
E	1.200	1.400	0.047	0.055
E1	2.250	2.550	0.089	0.100
e	0.950 TYP		0.037 TYP	
e1	1.800	2.000	0.071	0.079
L	0.550 REF		0.022 REF	
L1	0.300	0.500	0.012	0.020
θ	0°	8°	0°	8°

SOT-23 Tape and Reel

SOT-23 Embossed Carrier Tape

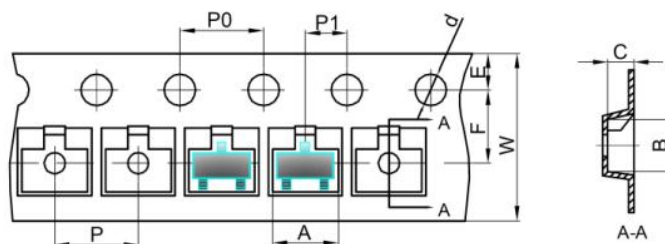

Dimensions are in millimeter										
Pkg type	A	B	C	d	E	F	P0	P	P1	W
SOT-23	3.15	2.77	1.22	Ø1.50	1.75	3.50	4.00	4.00	2.00	8.00

SOT-23 Tape Leader and Trailer

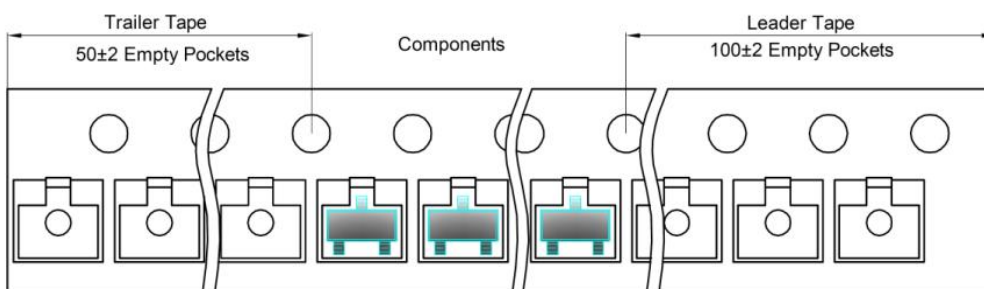

SOT-23 Reel

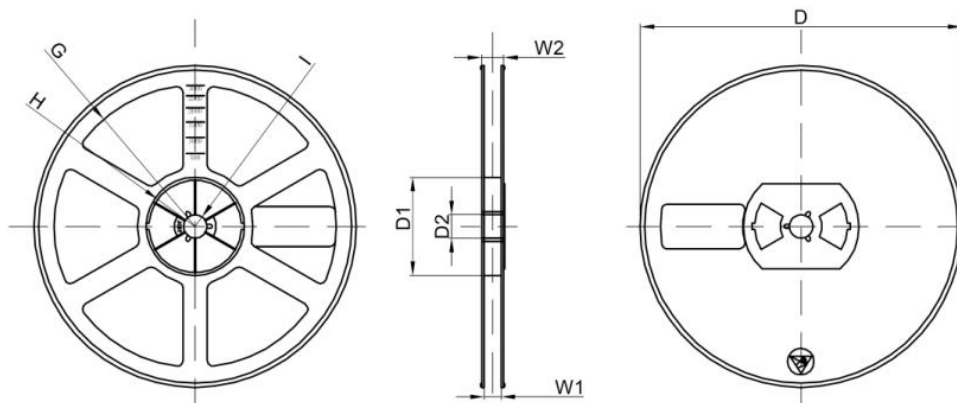

Dimensions are in millimeter								
Reel Option	D	D1	D2	G	H	I	W1	W2
7" Dia	Ø178.00	54.40	13.00	R78.00	R25.60	R6.50	9.50	12.30

REEL	Reel Size	Box	Box Size(mm)	Carton	Carton Size(mm)	G.W.(kg)
3000 pcs	7 inch	30,000 pcs	203×203×195	120,000 pcs	438×438×220	