

PW2312

20V N-Channel MOSFET

6.0A 20V; $R_{DS(ON)typ}=17m\Omega@4.5V$, $R_{DS(ON)typ}=20m\Omega@2.5V$,
 $R_{DS(ON)typ}=30m\Omega@1.8V$

FEATURE

- TrenchFET Power MOSFET
- Excellent $R_{DS(on)}$ and Low Gate Charge

Application

- DC/DC Converter
- Load Switch for Portable Devices
- Battery Switch

MARKING:

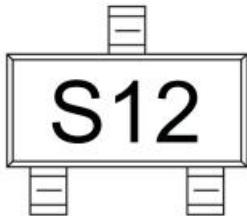

SOT-23

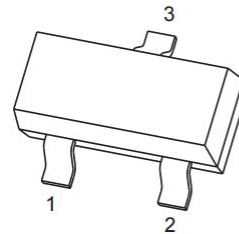

1. GATE
2. SOURCE
3. DRAIN

Schematic diagram

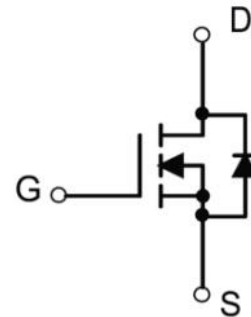

ABSOLUTE MAXIMUM RATINGS ($T_a=25^\circ\text{C}$ unless otherwise noted)

Parameter	Symbol	Value	Unit
Drain - Source Voltage	V_{DS}	20	V
Gate - Source Voltage	V_{GS}	± 8	V
Continuous Drain Current ^{1,5}	I_D	5	A
Pulsed Drain Current ²	I_{DM}	20	A
Power Dissipation ^{4,5}	P_D	1.5	W
Thermal Resistance from Junction to Ambient ⁵	$R_{\theta JA}$	83.3	$^\circ\text{C/W}$
Junction and Storage Temperature Range	T_J, T_{STG}	-55~+150	$^\circ\text{C}$

MOSFET ELECTRICAL CHARACTERISTICS(T_a=25°C unless otherwise noted)

Parameter	Symbol	Test Condition	Min	Type	Max	Unit
Static Characteristics						
Drain-source breakdown voltage	V _{(BR)DSS}	V _{GS} = 0V, I _D = 250μA	20			V
Zero gate voltage drain current	I _{DSS}	V _{DS} = 20V, V _{GS} = 0V			1	μA
Gate-body leakage current	I _{GSS}	V _{GS} = ±8V, V _{DS} = 0V			±0.1	μA
Gate threshold voltage	V _{GS(th)}	V _{DS} = V _{GS} , I _D = 250μA	0.45	0.7	1.0	V
Drain-source on-resistance ³	R _{DS(on)}	V _{GS} = 4.5V, I _D = 5.0A		17	24	mΩ
		V _{GS} = 2.5V, I _D = 4.7A		20	32	
		V _{GS} = 1.8V, I _D = 4.3A		30	42	
Forward tranconductance ³	g _{FS}	V _{DS} = 10V, I _D = 5A	6			S
Dynamic characteristics						
Input Capacitance	C _{iss}	V _{DS} = 10V, V _{GS} = 0V, f = 1MHz		865		pF
Output Capacitance	C _{oss}			105		
Reverse Transfer Capacitance	C _{rss}			55		
Gate resistance	R _g	f = 1MHz	0.5		4.8	Ω
Switching Characteristics						
Turn-on delay time	t _{d(on)}	V _{GEN} = 5V, V _{DD} = 10V, I _D = 4A, R _G = 1Ω, R _L = 2.2Ω			10	ns
Turn-on rise time	t _r				20	
Turn-off delay time	t _{d(off)}				32	
Turn-off fall time	t _f				12	
Source-Drain Diode characteristics						
Diode Forward voltage ³	V _{DS}	V _{GS} = 0V, I _S = 4A		0.75	1.2	V

Notes:

- The maximum current rating is limited by package.
- Pulse Test : Pulse Width ≤ 10μs, duty cycle ≤ 1%.
- Pulse Test : Pulse Width ≤ 300μs, duty cycle ≤ 2%.
- The power dissipation P_D is limited by T_{J(MAX)} = 150°C.
- Device mounted on 1in² FR-4 board with 2oz. Copper, in a still air environment with T_A = 25°C.

Typical Electrical and Thermal Characteristics

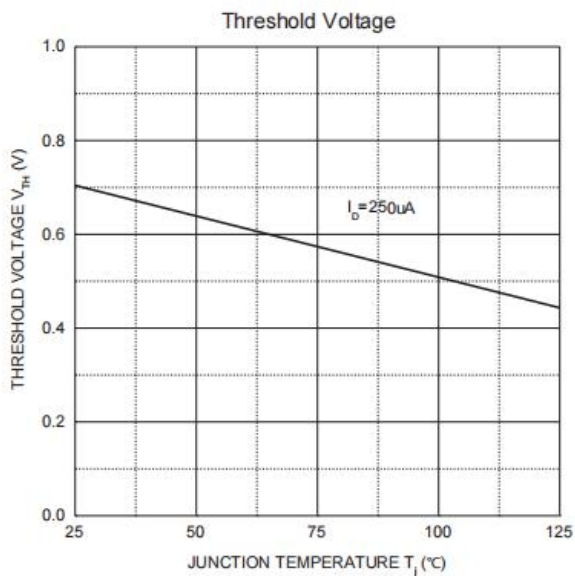
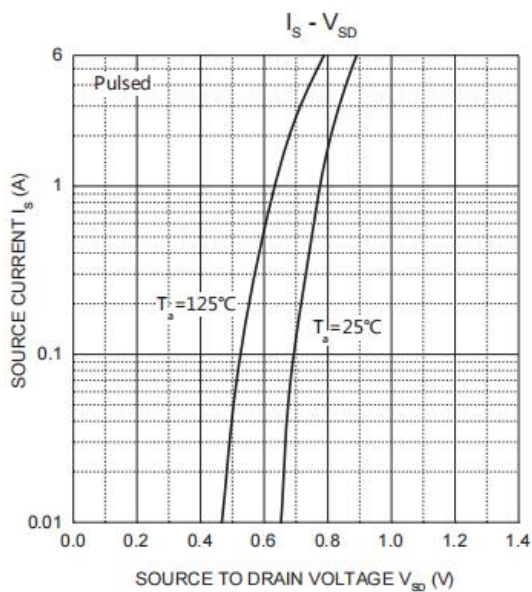
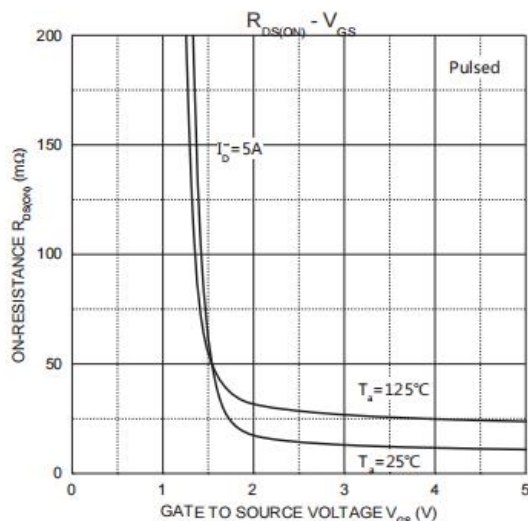
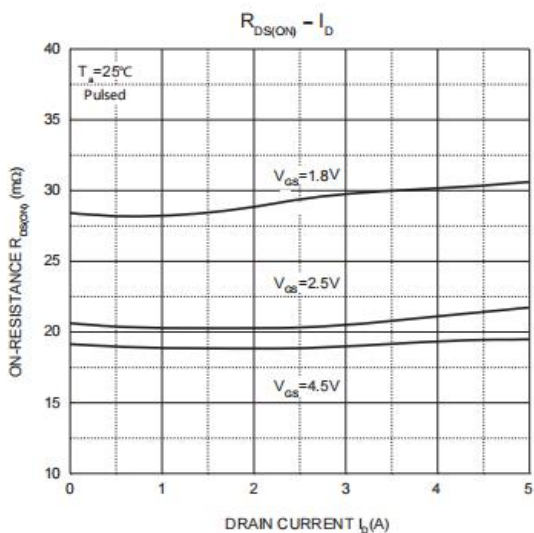
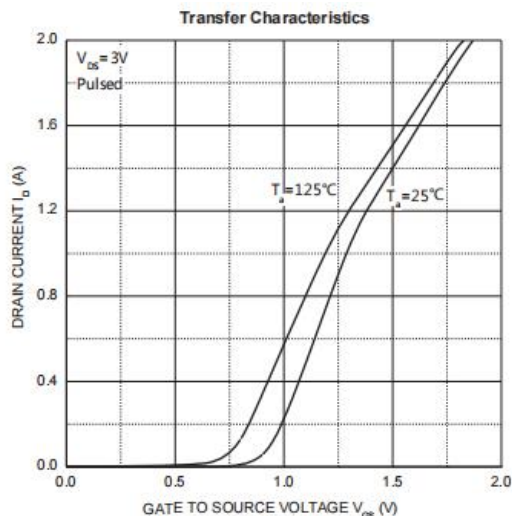
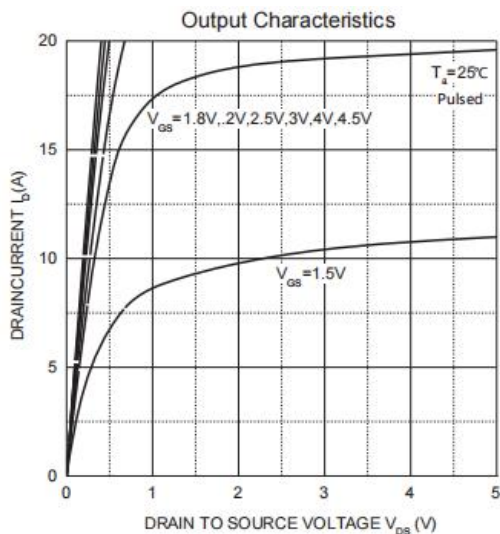

SOT-23 Package Information

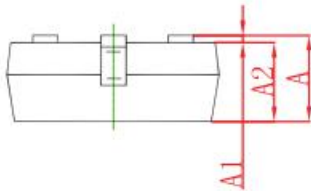
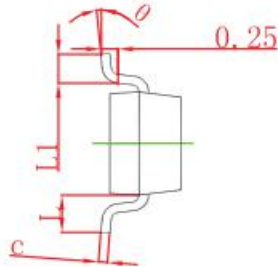
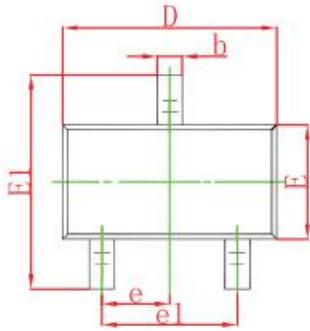

Symbol	Dimensions In Millimeters		Dimensions In Inches	
	Min	Max	Min	Max
A	0.900	1.150	0.035	0.045
A1	0.000	0.100	0.000	0.004
A2	0.900	1.050	0.035	0.041
b	0.300	0.500	0.012	0.020
c	0.080	0.150	0.003	0.006
D	2.800	3.000	0.110	0.118
E	1.200	1.400	0.047	0.055
E1	2.250	2.550	0.089	0.100
e	0.950 TYP		0.037 TYP	
e1	1.800	2.000	0.071	0.079
L	0.550 REF		0.022 REF	
L1	0.300	0.500	0.012	0.020
θ	0°	8°	0°	8°

SOT-23 Tape and Reel

SOT-23 Embossed Carrier Tape

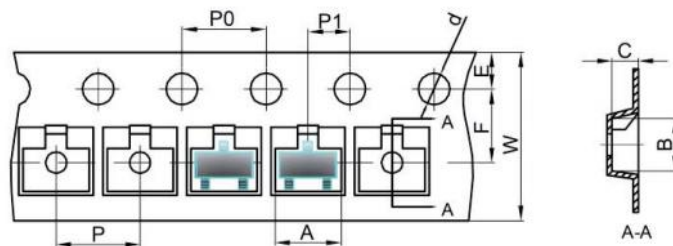

Dimensions are in millimeter										
Pkg type	A	B	C	d	E	F	P0	P	P1	W
SOT-23	3.15	2.77	1.22	Ø1.50	1.75	3.50	4.00	4.00	2.00	8.00

SOT-23 Tape Leader and Trailer

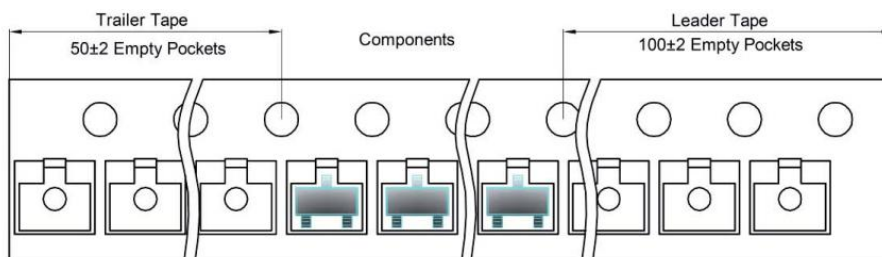

SOT-23 Reel

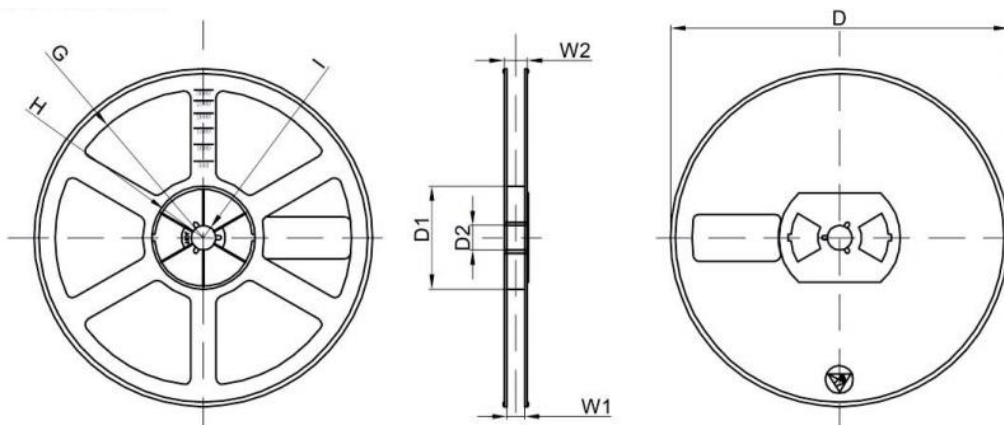

Dimensions are in millimeter								
Reel Option	D	D1	D2	G	H	I	W1	W2
7" Dia	Ø178.00	54.40	13.00	R78.00	R25.60	R6.50	9.50	12.30

REEL	Reel Size	Box	Box Size(mm)	Carton	Carton Size(mm)	G.W.(kg)
3000 pcs	7 inch	30,000 pcs	203×203×195	120,000 pcs	438×438×220	